

Met afdichtingsprofiel

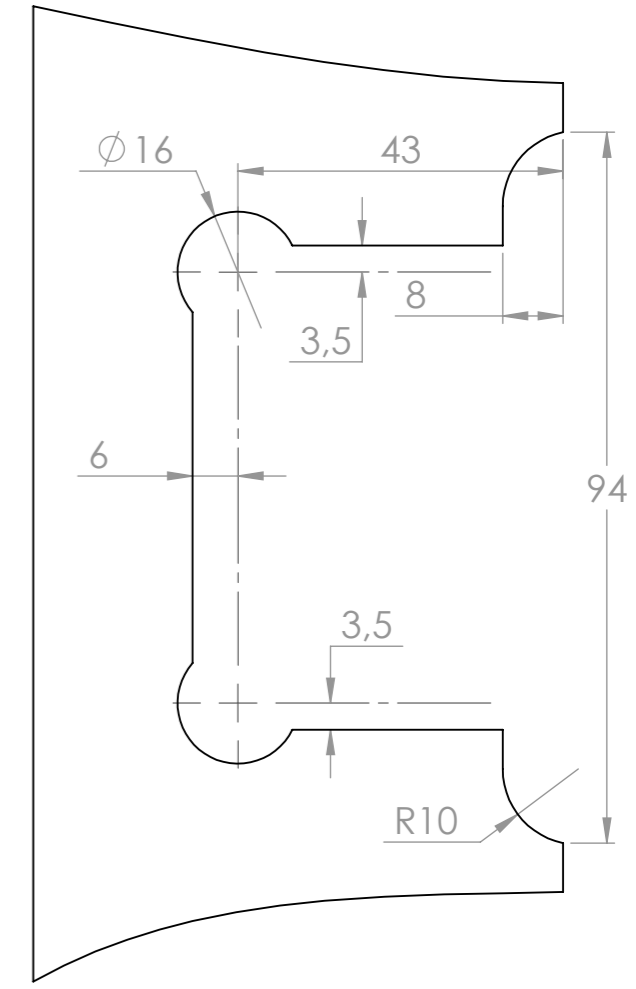

Zonder afdichtingsprofiel

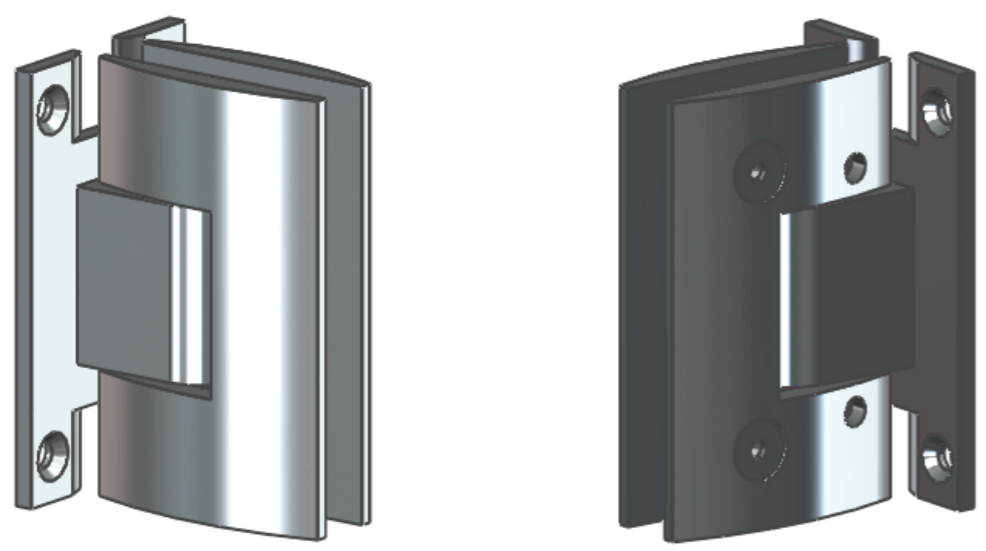

Minusco Basics

UNLESS OTHERWISE SPECIFIED: DIMENSIONS ARE IN MILLIMETERS GENERAL ROUGHNESS: TOLERANCES: - LINEAR: ± 0.5 mm - ANGULAR:		TREATMENT/FINISH: -		DEBUR AND BREAK SHARP EDGES		DO NOT SCALE DRAWING		REVISION -	
DRAWN L. Spruyt		SIGNATURE		DATE 1-1-2013		STOCKSIZE:		REMARKS:	
CHK'D		APPV'D		AMERIKAANSE PROJECTIE		TITLE: Adjustable Shower Hinge FACETTA		DWG NO. EF0109.010.xx	
UNITS: MM		MATERIAL: ...		WEIGHT: 694.52 gram		SCALE: 1:1		SHEET 1 OF 1	
								A3	