

FLUIDO+ 150 - KIT

Components

KB150CS0/3.2

- Kit scorrevole parete/soffitto con doppio soft-close.
- Kit corredizo de pared / techo con doble Soft-close
- Sliding wall / ceiling kit with double soft-close
- Schiebewand- / Deckensatz mit doppeltem Soft-Close
- Kit mur / plafond coulissant à double Soft-Close.

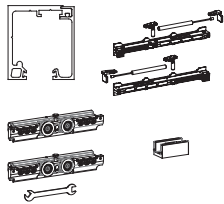

KB150SS0/3.2

- Kit scorrevole su vetro fisso con doppio soft-close.
- Kit corredizo sobre vidrio fijo con doble Soft-close
- Sliding kit on fixed glass with double soft-close
- Schiebesatz auf festem Glas mit doppeltem Soft-Close
- Kit coulissant sur verre fixe avec double Soft-Close

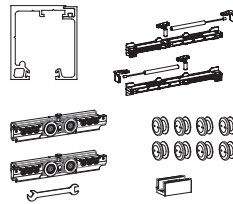

KB150FS0/3.2

- Kit scorrevole a soffitto con fisso, con doppio soft-close.
- Kit de techo corredizo fijo con doble Soft-close
- Fixed sliding ceiling kit with double soft-close
- Festes Schiebedeckenset mit doppeltem Soft-Close
- Kit plafond fixe coulissant avec à double Soft-Close

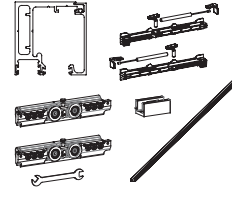

KB150CM0/3.2

- Kit scorrevole parete/soffitto con retainer e stop meccanico.
- Kit corredizo de techo / pared con retenedor y tope mecánico
- Sliding wall / ceiling kit with retainer and mechanical stop
- Schiebewand- / Deckensatz mit Halterung und mechanischem Anschlag
- Kit mur / plafond coulissant avec arrêtoir et butée mécanique

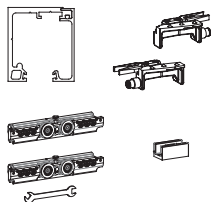

KB150SM0/3.2

- Kit scorrevole su vetro fisso con retainer e stop meccanico.
- Kit corredizo sobre vidrio fijo con retenedor y tope mecánico
- Sliding kit on fixed glass with retainer and mechanical stop
- Schiebesatz auf festem Glas mit Halter und mechanischem Anschlag
- Kit coulissant sur verre fixe avec arrêtoir et butée mécanique

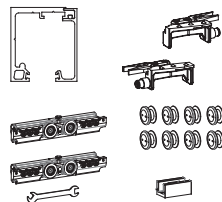

KB150FM0/3.2

- Kit scorrevole a soffitto con fisso, con retainer e stop meccanico.
- Kit de techo corredizo fijo, con retenedor y tope mecánico.
- Sliding ceiling kit with fixed, with retainer and mechanical stop
- Schiebedeckensatz mit fester, mit Halterung und mechanischem Anschlag
- Kit plafond coulissant avec fixe, avec arrêtoir et butée mécanique

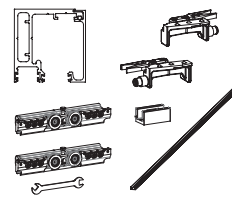

KB150CA0/3.2

- Kit scorrevole parete/soffitto con retainer e antishock.
- Kit corredizo de pared / techo con retenedor y Antishock
- Sliding wall / ceiling kit with retainer and Antishock
- KSchiebewand- / Deckensatz mit Halter und Antishock
- Kit mur / plafond coulissant avec retenue et Antishock

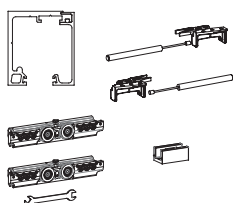

KB150SA0/3.2

- Kit scorrevole su vetro fisso con retainer e antishock.
- Kit corredizo sobre vidrio fijo con retenedor y Antishock
- Sliding kit on fixed glass with retainer and Antishock
- Schiebesatz auf festem Glas mit Halter und Antishock
- Kit coulissant sur verre fixe avec retenue et Antishock

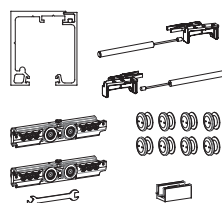

KB150FA0/3.2

- Kit scorrevole a soffitto con fisso, con retainer e antishock.
- Kit de techo corredizo con fija, con retenedor y Antishock
- Sliding ceiling kit with fixed, with retainer and Antishock
- Schiebedecken-Kit mit fester, mit Halter und Antishock
- Kit plafond coulissant avec fixe, avec retenue et Antishock

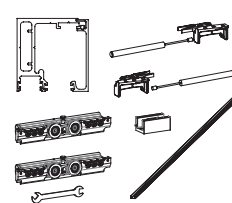

FLUIDO+ 150 - KIT

Components

B150EK10



- Kit coppia pinze con chiave
- Kit par de pinzas con llave
- Kit with pair of clamps with key
- Bausatz ein Paar Zangen mit Schlüssel
- Kit paire de pinces avec clé

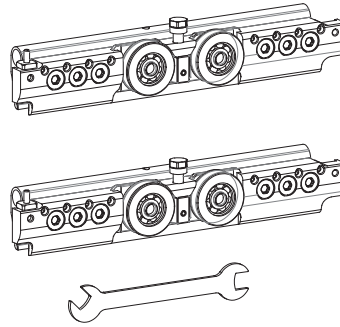

B150EK3NN

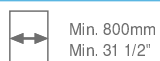

- Kit coppia Retainer. Stop meccanico
- Kit par tope mecánico
- Kit with pair of mechanical stops
- Bausatz ein Paar mechanische Stopper
- Kit paire arrêt mécanique

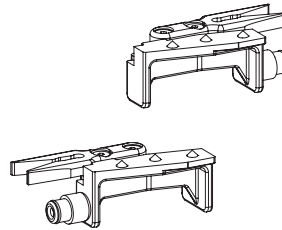

B150EK3AA

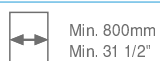

- Kit coppia Retainer + Antishock
- Kit par tope mecánico + antichoque
- Kit with pair of mechanical stops and anti-shock feature
- Bausatz ein Paar mechanische Stopper + Antishock
- Kit paire arrêt mécanique + butée antichoc

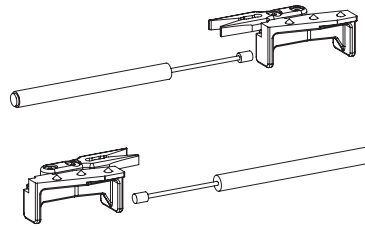

B150EK3SS

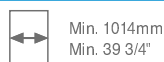

- Kit coppia Soft Close CPCS
- Kit par Soft Close CPCS
- Kit with Soft Close CPCS pair
- Bausatz ein Paar Soft Close CPCS
- Kit paire Soft Close CPCS

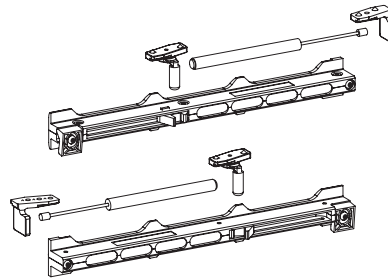

B150EP73

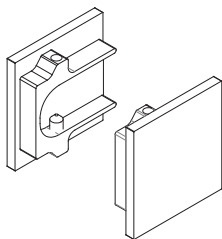

- Coppia di tappi.
- Par de tapones
- Pair of caps
- Paar Kappen
- Paire de bouchons

B150EP74

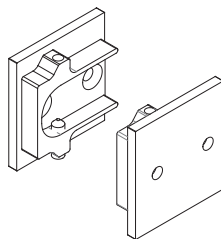

- Coppia di tappi forati.
- Par de tapones perforados
- Pair of perforated caps
- Paar Lochkappen
- Paire de bouchons perforés

B150EP75

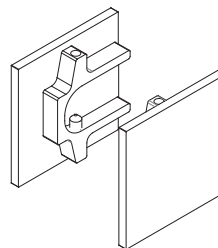

- Coppia di tappi per versione con fisso laterale.
- Par de tapones para versión con cristal fijo lateral
- Pair of caps for model with side fixed glass
- Paar Kappen für Version mit festem Seitenglas
- Paire de bouchons pour version avec vitrage fixe latéral

B150EP76

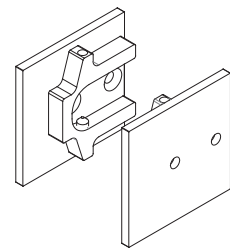

- Coppia di tappi forati per versione con fisso laterale.
- Par de tapones perforados para versión con cristal fijo lateral
- Pair of perforated caps for model with side fixed glass
- Paar Lochkappen für Version mit festem Seitenglas
- Paire de bouchons perforés pour version avec vitrage fixe latéral

FLUIDO+ 150 - COMPONENTI

Components

B150EP64

- Spessore per Velella - senza vetro fisso
Consigliato per binari oltre i 2,5m.
- Cuña para panel – sin cristal fijo
Aconsejado para perfiles de largo superior a 2,5 m
- Spacer for casing – without fixed glass
Recommended for rails longer than 2,5 m
- Distanzstück für Anlauf – ohne festes Glas.
Empfohlen für Profilen über 2,5 m
- Épaisseur pour panneau – sans vitrage fixe
Recommandé pour les profils de plus de 2,5 m



B150EP65

- Spessore per Velella - con vetro fisso
Consigliato per binari oltre i 2,5m.
- Cuña para panel – con cristal fijo
Aconsejado para perfiles de largo superior a 2,5 m
- Spacer for casing – with fixed glass
Recommended for rails longer than 2,5 m
- Distanzstück für Anlauf – mit festem Glas
Empfohlen für Profilen über 2,5 m
- Épaisseur pour panneau – avec vitrage fixe
Recommandé pour les profils de plus de 2,5 m



B150EP77

- Coppia supporti laterali
- Par de soportes laterales
- Pair of side fittings
- Paar Seitenträger
- Paire de supports latéraux

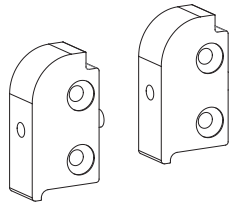

B150EP48

- Tassello di collegamento - per vetro fisso
- Pieza de unión - para cristal fijo
- Connection insert - for fixed glass
- Verbindungsdübel - für festem Glas
- Tasseau d'assemblage - pour vitrage fixe

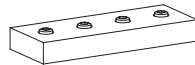

BF50

- Guida a terra.
- Guía de suelo
- Ground slide
- Bodenführung
- Guide au sol

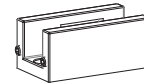

SPZ-FP

- Guarnizione a spazzola in tessuto
- Guarnición de tela
- Fabric brush seal
- Stoffbürstendichtung
- Joint de brosse en tissu



SPZ-FP

SPZ-FPBL



SPZ-FPBL

B150EP85

- Kit accessorio per porte in legno.
- Kit accesorios para puertas de madera.
- Accessory kit for wooden doors.
- Zubehörkit für Holztüren.
- Kit accessoires pour portes en bois.

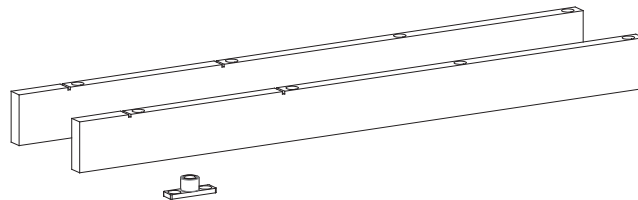

BF70

- Borchia per fissaggio barra a vetro.
- Perno de fijación de la barra al cristal
- Boss for securing glass bar
- Senkschraube zur Befestigung der Stange am Glas
- Clou de fixation de la barre à la vitre

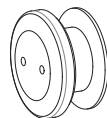

Lunghezza barra

Longitud de la barra
Bar length
Profillänge
Longueur de barre

Quantità borchie

Cantidad tornillos
Quantity of studs
Anzahl der Stifte
Quantité

2 mt	5
3,2 mt	8
4 mt	10
6 mt	15