

# FLUIDO+ 110 PORTE IN VETRO - GLASS DOORS

## Soluzioni - Solutions

### SCORREVOLE A SOFFITTO

Sliding on Ceiling

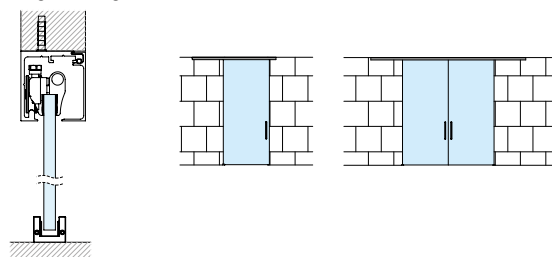

### SCORREVOLE A PARETE

Sliding on Wall

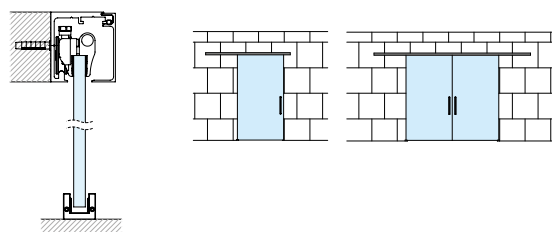

### SCORREVOLE SU VETRO FISSO

Sliding on Sidelight

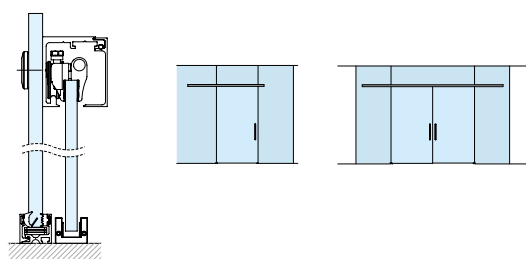

### SCORREVOLE A SOFFITTO CON FISSO

Sliding on Ceiling with Sidelight

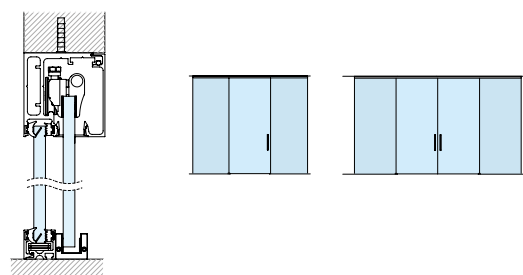

### SCORREVOLE A FALSO SOFFITTO

Sliding on False Ceiling

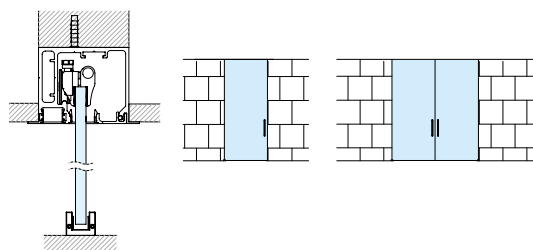

### SCORREVOLE A FALSO SOFFITTO CON FISSO

Sliding on False Ceiling with Sidelight

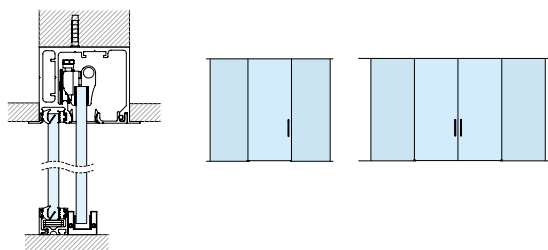

## Caratteristiche Tecniche Profili - Profiles Technical Characteristics

### SCORREVOLE A SOFFITTO

Sliding on Ceiling

60 x 55.5 mm

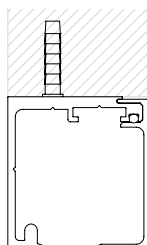

### SCORREVOLE A PARETE

Sliding on Wall

60 x 55.5 mm

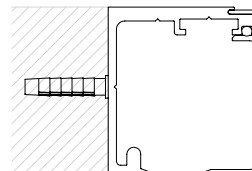

### SCORREVOLE SU VETRO FISSO

Sliding on Sidelight

60 x 55.5 mm

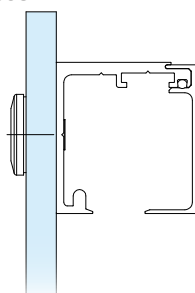

### SCORREVOLE A SOFFITTO CON FISSO

Sliding on Ceiling with Sidelight

72 x 69.5 mm

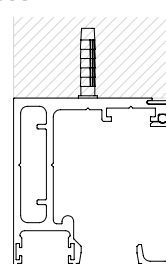

### SCORREVOLE A FALSO SOFFITTO

Sliding on False Ceiling

85,4 x 72 mm

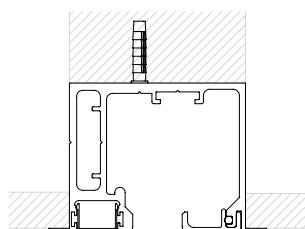

### SCORREVOLE A FALSO SOFFITTO CON FISSO

Sliding on False Ceiling with Sidelight

85,4 x 72 mm

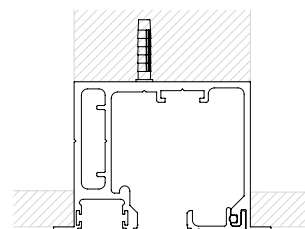

# FLUIDO+ 110 PORTE IN LEGNO - WOODEN DOORS

## Soluzioni - Solutions

### SCORREVOLE A SOFFITTO - PORTA IN LEGNO

Sliding on Ceiling - Wooden Door

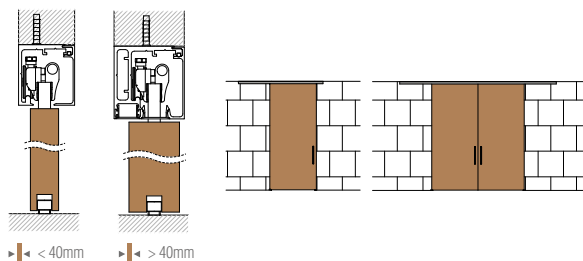

### SCORREVOLE A PARETE - PORTA IN LEGNO

Sliding on Wall - Wooden Door

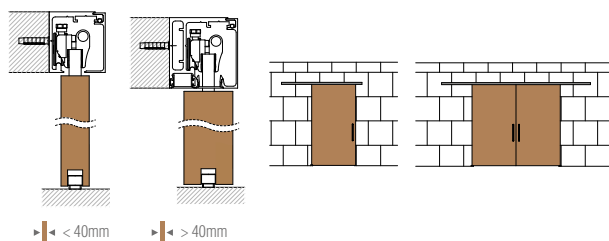

### SCORREVOLE A SOFFITTO - PORTA IN LEGNO CON FISSO

Sliding on Ceiling - Wooden Door with Sidelight

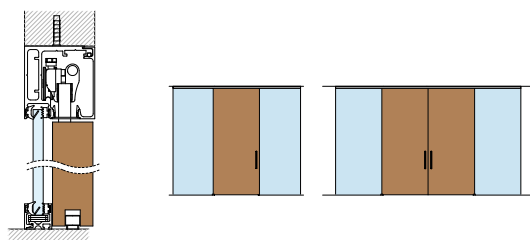

# FLUIDO+ 110 PORTE IN LEGNO - WOODEN DOORS

## Caratteristiche Tecniche Profili - Profiles Technical Characteristics

### SCORREVOLE A SOFFITTO - PORTA IN LEGNO

Sliding on Ceiling - Wooden Door

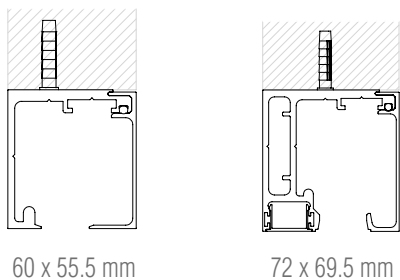

60 x 55.5 mm

72 x 69.5 mm

### SCORREVOLE A PARETE - PORTA IN LEGNO

Sliding on Wall - Wooden Door

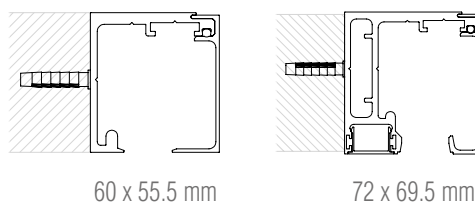

60 x 55.5 mm







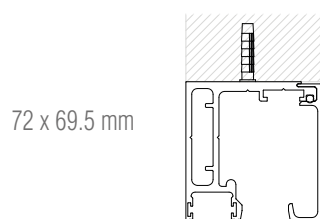









72 x 69.5 mm

### SCORREVOLE A SOFFITTO - PORTA IN LEGNO CON FISSO

Sliding on Ceiling - Wooden Door with Sidelight



72 x 69.5 mm

 <b>PORTATA</b> Weight	110kg per porta / for door 242lbs		
 <b>SPESSORE VETRO</b> Glass thickness	10 ÷ 12.76 mm 3/8" to 1/2"		
 <b>SPESSORE PORTA IN LEGNO</b> Wooden door thickness	28 ÷ 50 mm 1 1/8" to 1 15/16"		
 <b>REGOLAZIONE IN ALTEZZA</b> Height adjustment	6 mm 1/4"		
 <b>DISTANZA A PARETE</b> Wall distance	20 mm 13/16"		
 <b>DISTANZA TRA ANTA E VETRO FISSO</b> Distance between door and sidelight	14.8 ÷ 16.2 mm 9/16" to 5/8"		
 <b>INSTALLAZIONE A VETRO</b> Glass installation	✓		
 <b>INSTALLAZIONE A FALSO SOFFITTO</b> False ceiling installation	✓		
 <b>INSTALLAZIONE TRA PARETI</b> Installation between walls	✓		
 <b>SOFTCLOSE</b> Soft close	Doppio / Double		
 <b>DIMENSIONI MINIME (doppio Softclose)</b> Minimum dimensions (double soft close)	922 mm 36 1/4"		
 <b>ANTISHOCK</b> Antishock	Doppio / Double		
 <b>DIMENSIONI MINIME (doppio antishock)</b> Minimum dimensions (double antishock)	700 mm 27 9/16"		
 <b>RETAINER MECCANICO</b> Mechanical retainer	Doppio / Double		
 <b>DIMENSIONI MINIME (doppio Retainer)</b> Minimum dimensions (double Retainer)	700 mm 27 9/16"		
 <b>FINITURE</b> Finishes	<b>02</b> Ossidato naturale Natural oxidized	<b>05</b> Ossidato nero Black oxidized	<b>13</b> PVD simil inox similar PVD stainless steel



**CERTIFICAZIONE DURABILITÀ  
CICLI CORROSIONE**  
Durability certification  
Corrosion cycles

**DURABILITÀ (100.000 Cicli)**  
Durability (100.000 Cycles)

**PESO DELLA PORTA (da 101 a 330 kg)**  
Door mass (from 101 up to 330 kg)

**SICUREZZA (Grado 1 per tutti gli scorrevoli)**  
Safety (All sliding must be grade 1)

**RESISTENZA ALLA CORROSIONE (Alta resistenza)**  
Corrosion resistance (High resistance)

**CATEGORIA DELLA PORTA (Porta scorrevole)**  
Category of door (Sliding door)

**FRIZIONE INIZIALE VALORE MASSIMO CONSENTITO (4% della massa)**  
Initial friction maximum permitted value (4% of the mass)

according to  
**EN1527**

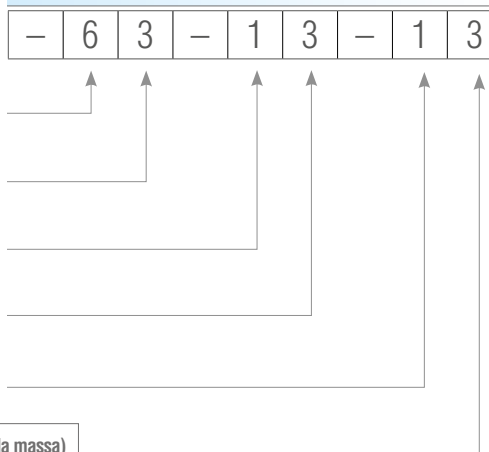

# FLUIDO+ 110

scorrevole a soffitto  
sliding on ceiling

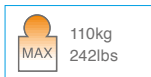
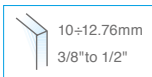

- Profili per scorrevole  
- fissaggio a soffitto/parete.
- Perfil para sistema corredero  
- fijación a techo/pared.
- Profiles for sliders  
- fixed on ceiling/wall.
- Schiebeseystem Fluido  
- Befestigung an der Decke/Wand.
- Profils pour coulissants  
- fixation au plafond/mur.

## LUNGHEZZE PROFILI - LENGTH OF PROFILES

B110EK00/2 ( 2 mt )

B110EK00/3 ( 3 mt )

B110EK00/4 ( 4 mt )

B110EK00/6 ( 6 mt )

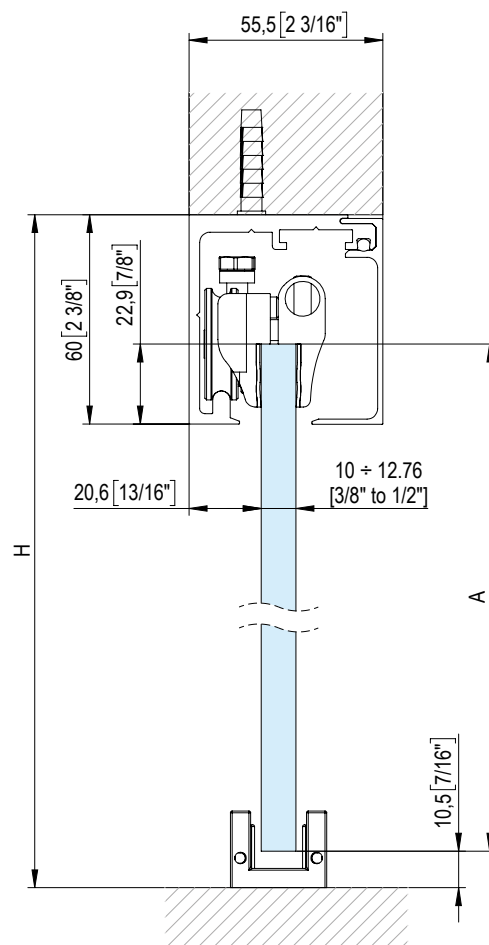
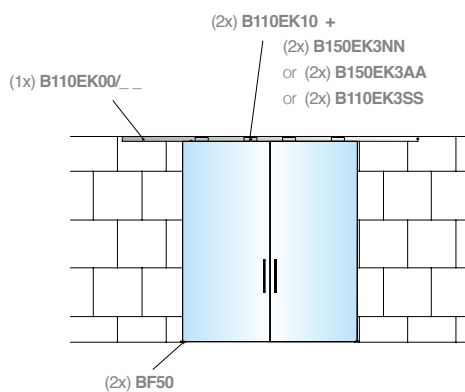
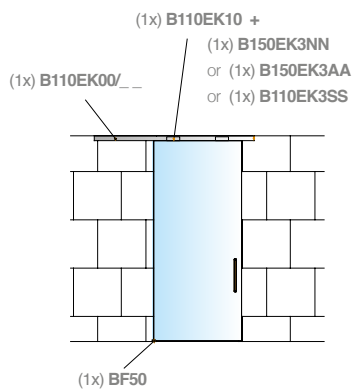
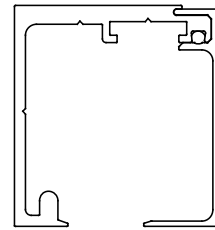

$$A = H - 48$$

$$[A = H - 1\ 7/8"]$$

L'installazione del Fluido 70, 110 e 150 non necessita di forature sul vetro. La instalación del "Fluido 70, 110 y 150" no necesita agujeros en el cristal. The installation of Fluido 70, 110 and 150 does not need holes on the glass. Die Systeme Fluido 70, 110 und 150 benötigen keine Glasbearbeitung. L'installation des coulissants Fluido 70, 110 et 150 ne requiert pas de perçage du verre.

# FLUIDO+ 110

scorrevole a parete  
sliding on wall

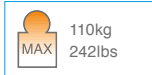
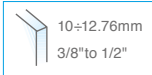

- Profili per scorrevole  
- fissaggio a soffitto/parete.
- Perfil para sistema corredero  
- fijación a techo/pared.
- Profiles for sliders  
- fixed on ceiling/wall.
- Schiebesystem Fluido  
- Befestigung an der Decke/Wand.
- Profils pour coulissants  
- fixation au plafond/mur.

## LUNGHEZZE PROFILI - LENGTH OF PROFILES

- B110EK00/2 (2 mt)
- B110EK00/3 (3 mt)
- B110EK00/4 (4 mt)
- B110EK00/6 (6 mt)

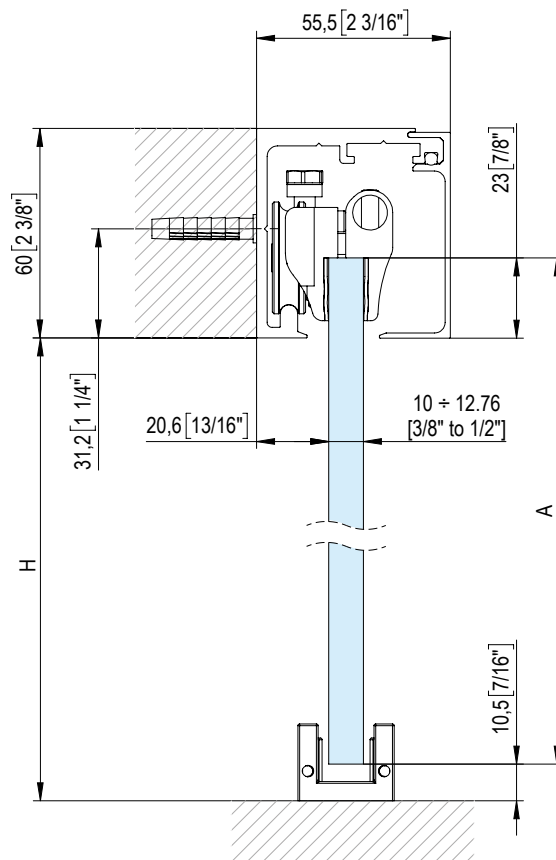
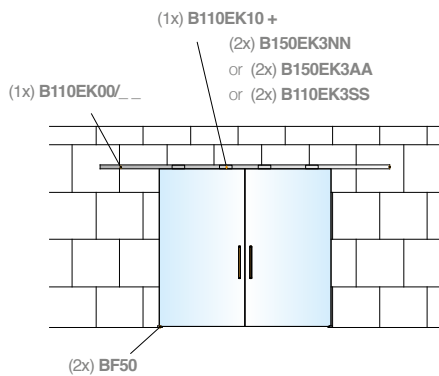
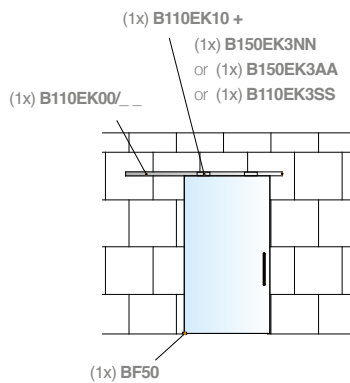
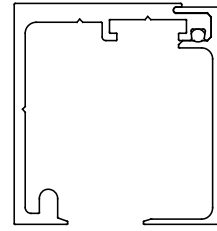

$$A = H + 12$$

$$[A = H + 1/2"]$$

L'installazione del Fluido 70, 110 e 150 non necessita di forature sul vetro. La instalación del "Fluido 70, 110 y 150" no necesita hojas en el cristal. The installation of Fluido 70, 110 and 150 does not need holes on the glass. Die Systeme Fluido 70, 110 und 150 benötigen keine Glasbearbeitung. L'installation des coulissants Fluido 70, 110 et 150 ne requiert pas de perçage du verre.

# FLUIDO+ 110

scorrevole su vetro fisso  
sliding on sidelight

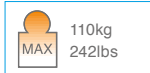

- Profili per scorrevole  
- fissaggio a soffitto/parete.
- Perfil para sistema corredero  
- fijación a techo/pared.
- Profiles for sliders  
- fixed on ceiling/wall.
- Schiebessystem Fluido  
- Befestigung an der Decke/Wand.
- Profils pour coulissants  
- fixation au plafond/mur.

## LUNGHEZZE PROFILI - LENGTH OF PROFILES

- B110EK00/2 (2 mt)
- B110EK00/3 (3 mt)
- B110EK00/4 (4mt)
- B110EK00/6 (6mt)

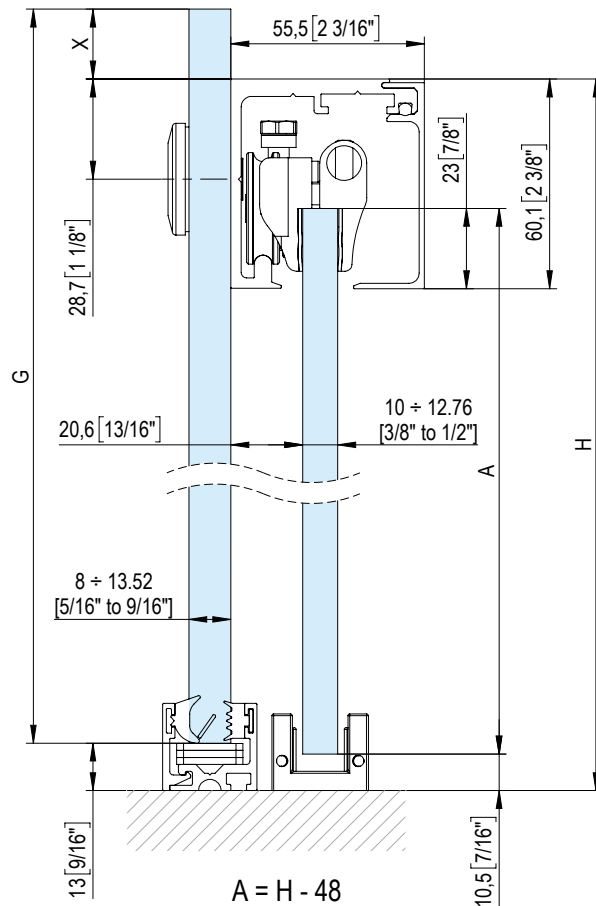
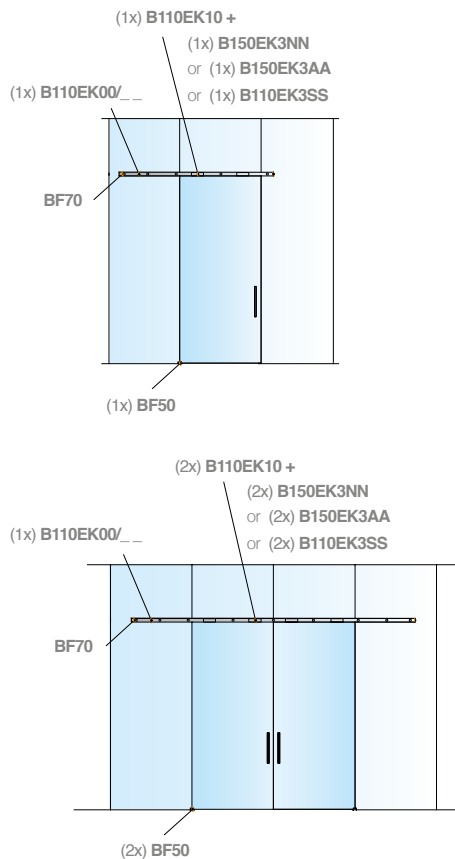
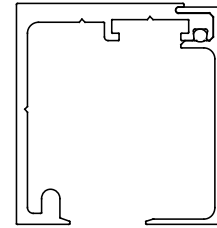

### NON INCLUSI - NOT INCLUDED

P20EJ0810/6 P20EJ1113/6 P20E29/58



Vedere scheda catalogo P20E nella sezione PARTIZIONI  
See P20E technical sheet in PARTITIONING section

$$A = H - 48$$

$$[A = H - 1 7/8"]$$

$$G = H + X - 13$$

$$[G = H + X - 1/2"]$$

L'installazione del Fluido 70, 110 e 150 non necessita di forature sul vetro. La instalación del "Fluido 70, 110 y 150" no necesita hojas en el cristal. The installation of Fluido 70, 110 and 150 does not need holes on the glass. Die Systeme Fluido 70, 110 und 150 benötigen keine Glasbearbeitung. L'installation des coulissants Fluido 70, 110 et 150 ne requiert pas de perçage du verre.

# FLUIDO+ 110

scorrevole a soffitto con fisso  
sliding on ceiling with sidelight

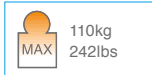

- Profili per scorrevole  
- fissaggio a soffitto con vetro fisso.
- Perfil para sistema corredero  
- fijación a techo con vidrio fijo.
- Profiles for sliders  
- fixed on ceiling with fixed glass.
- Schiebeseystem Fluido  
- Befestigung an Decke mit Seitenteilen aus Glas.
- Profils pour coulissant  
- fixation au plafond avec verre fixe.

## LUNGHEZZE PROFILI - LENGTH OF PROFILES

- B110EK01/2 ( 2 mt )
- B110EK01/3 ( 3 mt )
- B110EK01/4 ( 4 mt )
- B110EK01/6 ( 6 mt )

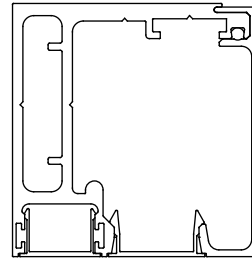

### OPTIONAL

- |                  |                  |
|------------------|------------------|
| B150EP45/2 (2mt) | B150EP46/2 (2mt) |
| B150EP45/3 (3mt) | B150EP46/3 (3mt) |
| B150EP45/4 (4mt) | B150EP46/4 (4mt) |
| B150EP45/6 (6mt) | B150EP46/6 (6mt) |

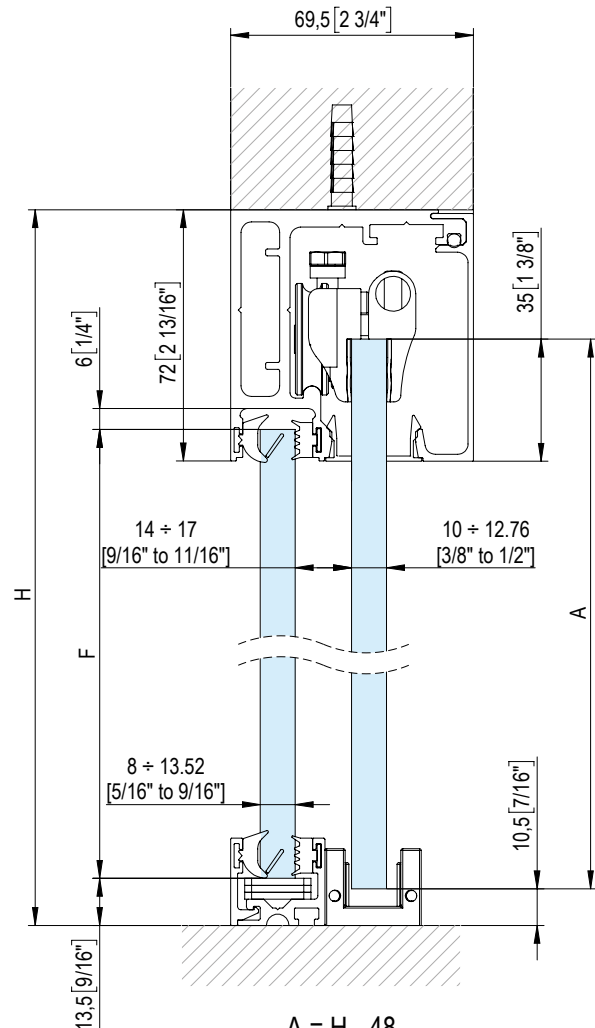
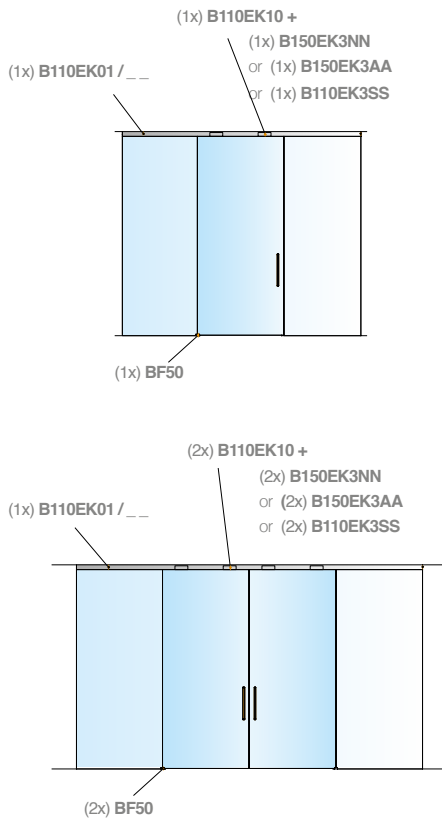

$$A = H - 48$$

$$[A = H - 1 7/8"]$$

$$F = H - 77$$

$$[F = H - 3 1/16"]$$

### NON INCLUSI - NOT INCLUDED

P20EJ0810/6 P20EJ1113/6 P20E29/58



Vedere scheda catalogo P20E nella sezione PARTIZIONI  
See P20E technical sheet in PARTITIONING section

L'installazione dei Fluido 70, 110 e 150 non necessita di forature sul vetro. La instalación del "Fluido 70, 110 y 150" no necesita agujeros en el cristal. The installation of Fluido 70, 110 and 150 does not need holes on the glass. Die Systeme Fluido 70, 110 und 150 benötigen keine Glasbearbeitung. L'installation des coulissants Fluido 70, 110 et 150 ne requiert pas de perçage du verre.





# FLUIDO+ 110

scorrevole a falso soffitto con fisso  
sliding on false ceiling with sidelight

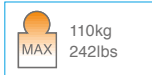

- Profili per scorrevole  
- fissaggio a falso soffitto con vetro fisso.
- Perfil para sistema corredor  
- fijación a cielo falso con vidrio fijo.
- Profiles for sliders  
- fixed on false ceiling with fixed glass.
- Profil für Schiebeseiten - Befestigung an abgehängter Decke mit Glasseitenteil.
- Profils pour coulissants  
- fixation faux-plafond avec verre fixe.

## LUNGHEZZE PROFILI - LENGTH OF PROFILES

B150EK02/2 (2 mt)

B150EK02/3 (3 mt)

B150EK02/3.2 (3,2 mt)

B150EK02/4 (4 mt)

B150EK02/6 (6 mt)

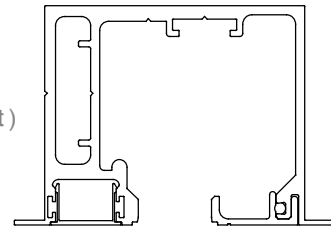

### OPTIONAL

B150EP45/2 (2mt)

B150EP45/3 (3mt)

B150EP45/4 (4mt)

B150EP45/6 (6mt)

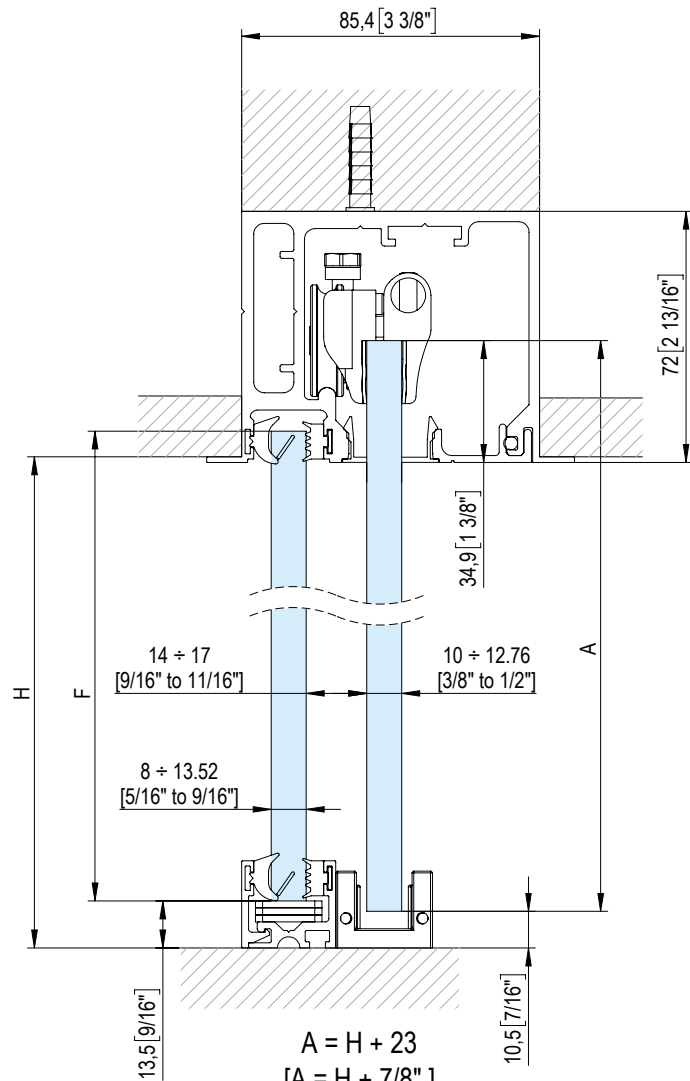
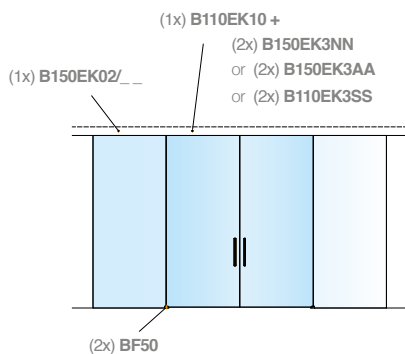
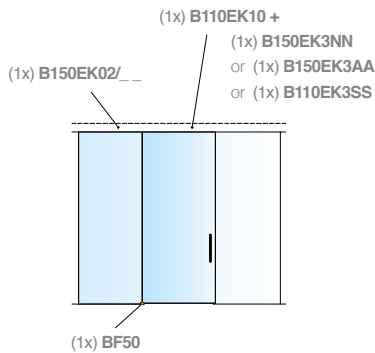

### NON INCLUSI - NOT INCLUDED

P20EJ0810/6

P20EJ1113/6

P20E29/58

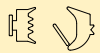

Vedere scheda catalogo P20E nella sezione PARTIZIONI  
See P20E technical sheet in PARTITIONING section

$$A = H + 23$$

$$[A = H + 7/8"]$$

$$F = H - 6$$

$$[F = H - 1/4"]$$

L'installazione dei Fluido 70, 110 e 150 non necessita di forature sul vetro. La instalación del "Fluido 70, 110 y 150" no necesita agujeros en el cristal. The installation of Fluido 70, 110 and 150 does not need holes on the glass. Die Systeme Fluido 70, 110 und 150 benötigen keine Glasbearbeitung. L'installation des coulissants Fluido 70, 110 et 150 ne requiert pas de perçage du verre.

# FLUIDO+ 110



scorrevole a soffitto - porta in legno  
sliding on ceiling - wooden door

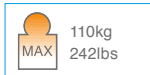

- Profili per scorrevole in legno  
- fissaggio a soffitto.
- Perfil para sistema corredero - puertas de madera  
- fijación a techo.
- Profiles for sliders - wooden doors  
- fixed on ceiling.
- Schiebeseystem Fluido - Holztüren  
- Befestigung an der Decke.
- Profils pour coulissants - Portes en bois  
- fixation au plafond.

## LUNGHEZZE PROFILI - LENGTH OF PROFILES

B110EK00/2 (2 mt)

B110EK00/3 (3mt)

B110EK00/4 (4mt)

B110EK00/6 (6mt)

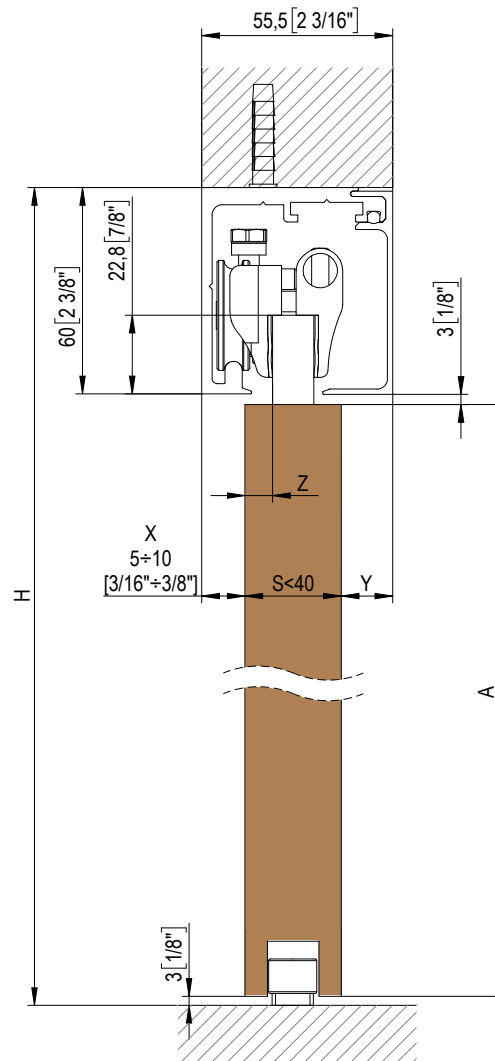
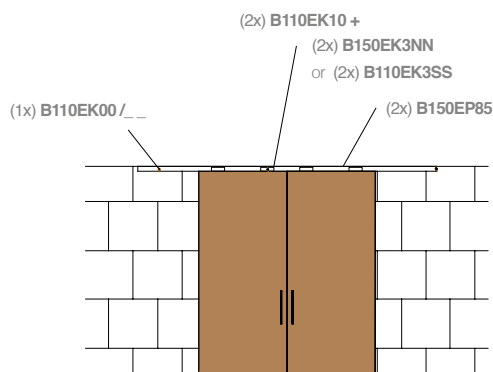
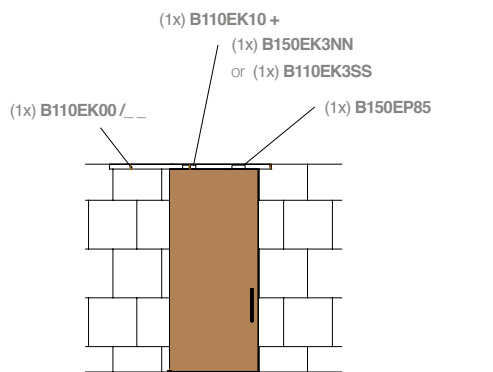
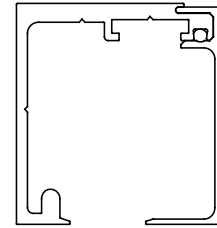

$$\begin{aligned}
 A &= H - 66 \\
 [A &= H - 2 \frac{5}{8}"] \\
 Y &= 55.5 - X - S \\
 [Y &= [2 \frac{3}{16}"] - X - S] \\
 Z &= 20 - X \\
 [Z &= 13 \frac{1}{16}"] - X]
 \end{aligned}$$

# FLUIDO+ 110



scorrevole a soffitto - porta in legno  
sliding on ceiling - wooden door

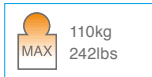

- Profili per scorrevole in legno - fissaggio a soffitto.
- Perfil para sistema corredero - puertas de madera - fijación a techo.
- Profiles for sliders - wooden doors - fixed on ceiling.
- Schiebeseystem Fluido - Holztüren - Befestigung an der Decke.
- Profils pour coulissants - Portes en bois - fixation au plafond.

## LUNGHEZZE PROFILI - LENGTH OF PROFILES

- B110EK01/2** ( 2 mt )
- B110EK01/3** ( 3 mt )
- B110EK01/4** ( 4 mt )
- B110EK01/6** ( 6 mt )

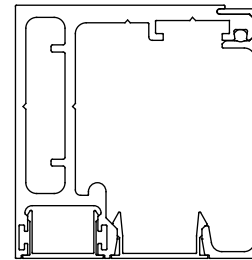

### OPTIONAL

- |                  |                  |
|------------------|------------------|
| B150EP45/2 (2mt) | B150EP46/2 (2mt) |
| B150EP45/3 (3mt) | B150EP46/3 (3mt) |
| B150EP45/4 (4mt) | B150EP46/4 (4mt) |
| B150EP45/6 (6mt) | B150EP46/6 (6mt) |

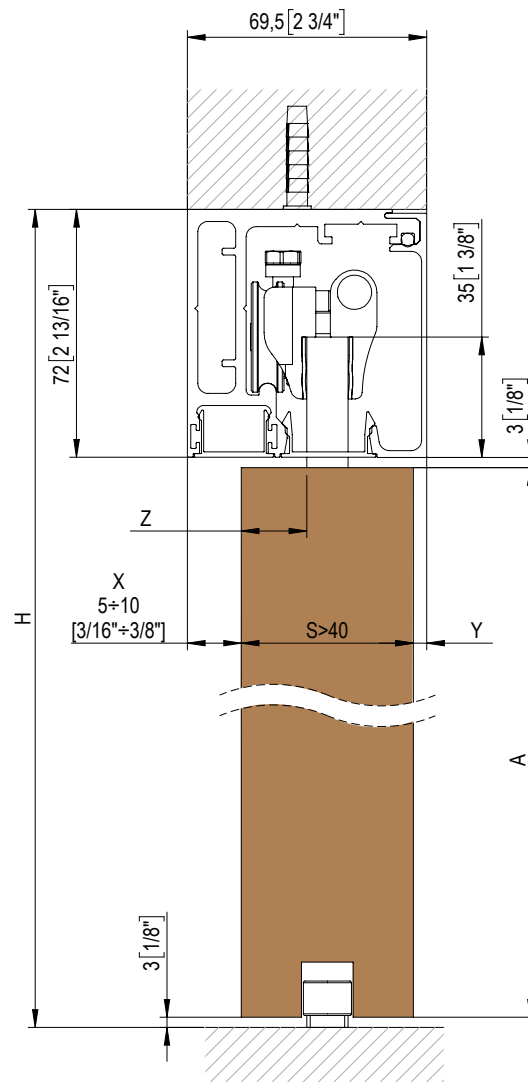
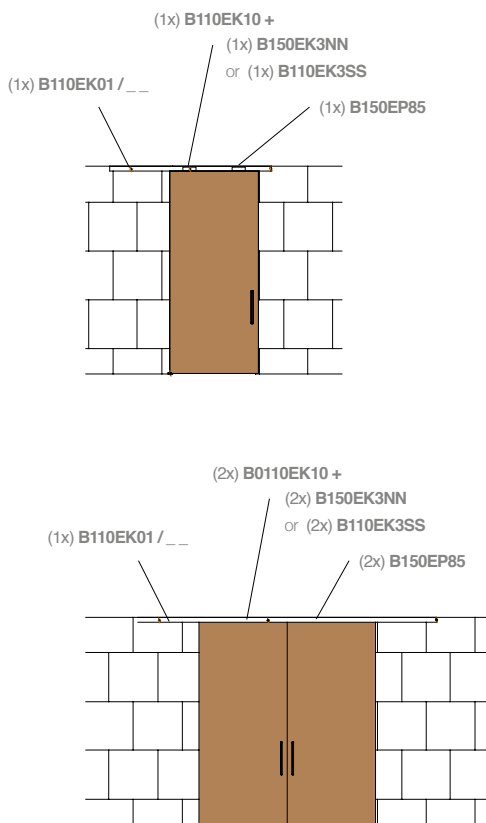

$$\begin{aligned}
 A &= H - 78 \\
 [A &= H - 3 \frac{1}{16}"] \\
 Y &= 69.5 - X - S \\
 [Y &= [2 \frac{3}{4} - X - S] \\
 Z &= 34 - X \\
 [Z &= 1 \frac{5}{16} - X]
 \end{aligned}$$

# FLUIDO+ 110



scorrevole a parete - porta in legno  
sliding on wall - wooden door

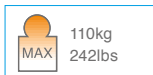
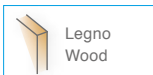

- Profili per scorrevole in legno  
- fissaggio a parete.
- Perfil para sistema corredero - puertas de madera  
- fijación a pared.
- Profiles for sliders - wooden doors  
- fixed on wall.
- Schiebeseystem Fluido - Holztüren  
- Befestigung an der Wand.
- Profils pour coulissants - Portes en bois  
- fixation au mur.

## LUNGHEZZE PROFILI - LENGTH OF PROFILES

B110EK00/2 (2 mt)

B110EK00/3 (3 mt)

B110EK00/4 (4mt)

B110EK00/6 (6mt)

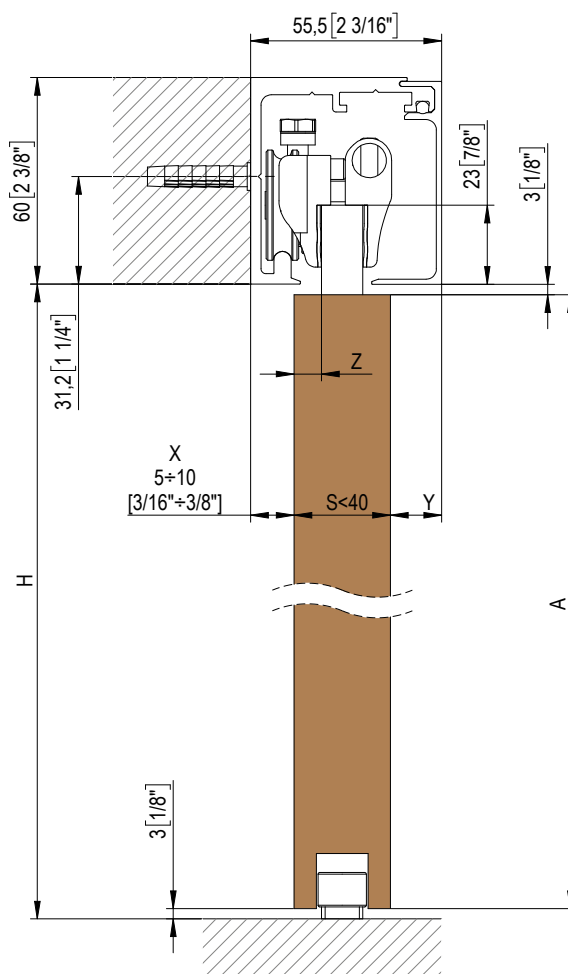
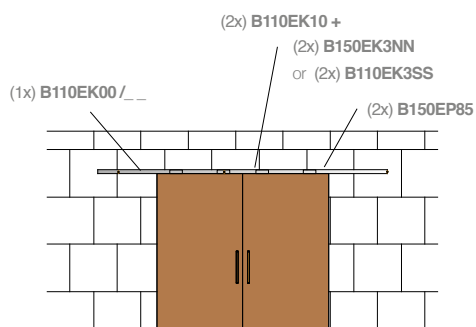
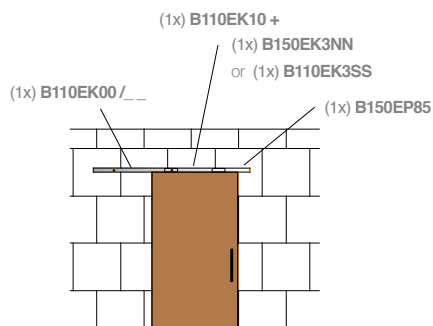
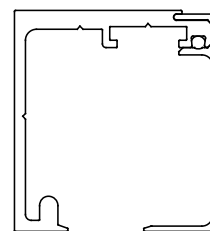

$$\begin{aligned}
 A &= H - 6 \\
 [A &= H - 1/4"] \\
 Y &= 55.5 - X - S \\
 [Y &= [2 \ 3/16" - X - S] \\
 Z &= 20 - X \\
 [Z &= 13/16" - X]
 \end{aligned}$$

# FLUIDO+ 110



scorrevole a parete - porta in legno  
sliding on wall - wooden door

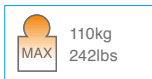
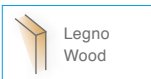

- Profili per scorrevole in legno  
- fissaggio a parete.
- Perfil para sistema corredero - puertas de madera  
- fijación a pared.
- Profiles for sliders - wooden doors  
- fixed on wall.
- Schiebeseystem Fluido - Holztüren  
- Befestigung an der Wand.
- Profils pour coulissants - Portes en bois  
- fixation au mur.

## LUNGHEZZE PROFILI - LENGTH OF PROFILES

- B110EK01/2 ( 2 mt )
- B110EK01/3 ( 3 mt )
- B110EK01/4 ( 4 mt )
- B110EK01/6 ( 6 mt )

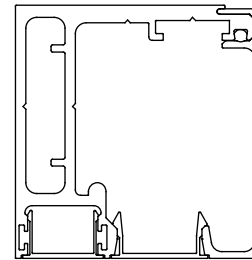

### OPTIONAL

- |                  |                  |
|------------------|------------------|
| B150EP45/2 (2mt) | B150EP46/2 (2mt) |
| B150EP45/3 (3mt) | B150EP46/3 (3mt) |
| B150EP45/4 (4mt) | B150EP46/4 (4mt) |
| B150EP45/6 (6mt) | B150EP46/6 (6mt) |

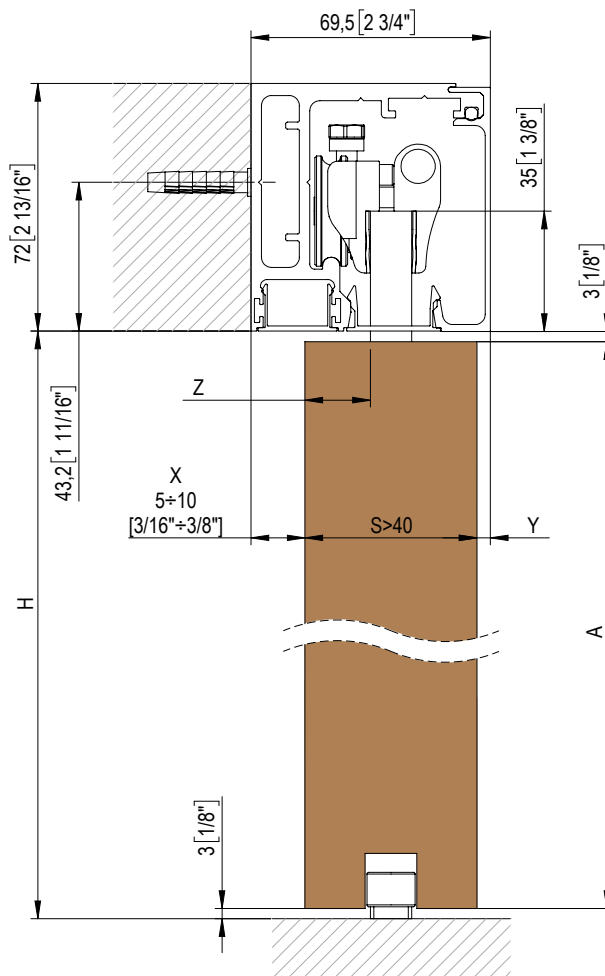
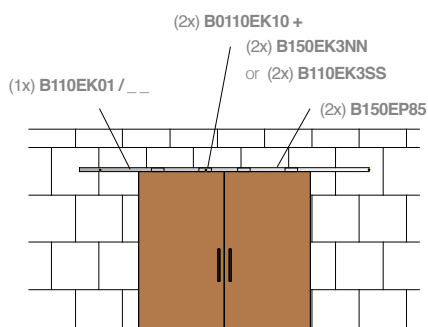
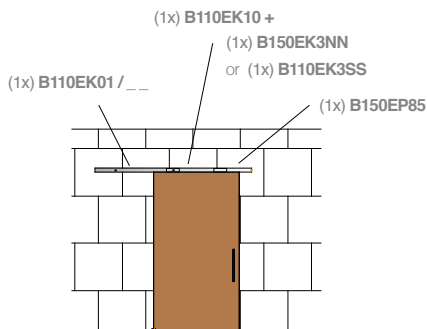

$$\begin{aligned}
 A &= H - 6 \\
 [A &= H - 1/4"] \\
 Y &= 69.5 - X - S \\
 [Y &= [2 3/4" - X - S] \\
 Z &= 34 - X \\
 [Z &= 1 5/16" - X]
 \end{aligned}$$



# FLUIDO+ 110 -KIT

## Components

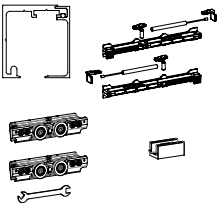
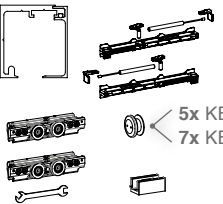
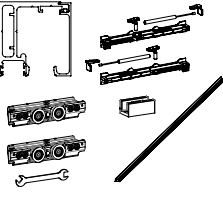
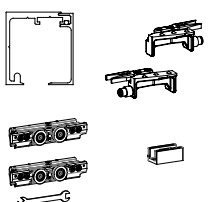
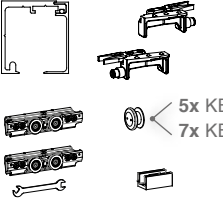
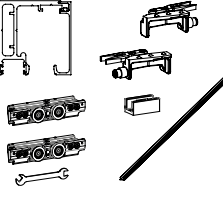
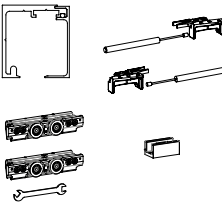
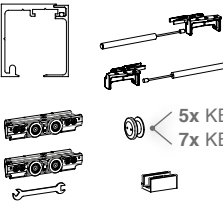
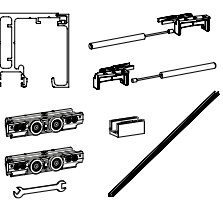
<p><b>KB110CS0/2</b></p> <p><b>KB110CS0/3</b></p> <ul style="list-style-type: none"> <li>• Kit scorrevole parete/soffitto con doppio soft-close.</li> <li>• Kit corredizo de pared / techo con doble Soft-close</li> <li>• Sliding wall / ceiling kit with double soft-close</li> <li>• Schiebewand- / Deckensatz mit doppelem Soft-Close</li> <li>• Kit mur / plafond coulissant à double Soft-Close.</li> </ul> 	<p><b>KB110SS0/2</b></p> <p><b>KB110SS0/3</b></p> <ul style="list-style-type: none"> <li>• Kit scorrevole su vetro fisso con doppio soft-close.</li> <li>• Kit corredizo sobre vidrio fijo con doble Soft-close</li> <li>• Sliding kit on fixed glass with double soft-close</li> <li>• Schiebesatz auf festem Glas mit doppelem Soft-Close</li> <li>• Kit coulissant sur verre fixe avec double Soft-Close</li> </ul>  <p>5x KB110SS0/2 7x KB110SS0/3</p>	<p><b>KB110FS0/2</b></p> <p><b>KB110FS0/3</b></p> <ul style="list-style-type: none"> <li>• Kit scorrevole a soffitto con fisso, con doppio soft-close.</li> <li>• Kit de techo corredizo fijo con doble Soft-close</li> <li>• Fixed sliding ceiling kit with double soft-close</li> <li>• Festes Schiebedeckenset mit doppelem Soft-Close</li> <li>• Kit plafond fixe coulissant avec à double Soft-Close</li> </ul> 
<p><b>KB110CM0/2</b></p> <p><b>KB110CM0/3</b></p> <ul style="list-style-type: none"> <li>• Kit scorrevole parete/soffitto con retainer e stop meccanico.</li> <li>• Kit corredizo de techo / pared con retenedor y tope mecánico</li> <li>• Sliding wall / ceiling kit with retainer and mechanical stop</li> <li>• Schiebewand- / Deckensatz mit Halterung und mechanischem Anschlag</li> <li>• Kit mur / plafond coulissant avec arrière et butée mécanique</li> </ul> 	<p><b>KB110SM0/2</b></p> <p><b>KB110SM0/3</b></p> <ul style="list-style-type: none"> <li>• Kit scorrevole su vetro fisso con retainer e stop meccanico.</li> <li>• Kit corredizo sobre vidrio fijo con retenedor y tope mecánico</li> <li>• Sliding kit on fixed glass with retainer and mechanical stop</li> <li>• Schiebesatz auf festem Glas mit Halter und mechanischem Anschlag</li> <li>• Kit coulissant sur verre fixe avec arrière et butée mécanique</li> </ul>  <p>5x KB110SM0/2 7x KB110SM0/3</p>	<p><b>KB110FM0/2</b></p> <p><b>KB110FM0/3</b></p> <ul style="list-style-type: none"> <li>• Kit scorrevole a soffitto con fisso, con retainer e stop meccanico.</li> <li>• Kit de techo corredizo fijo, con retenedor y tope mecánico.</li> <li>• Sliding ceiling kit with fixed, with retainer and mechanical stop</li> <li>• Schiebedeckensatz mit fester, mit Halterung und mechanischem Anschlag</li> <li>• Kit plafond coulissant avec fixe, avec arrière et butée mécanique</li> </ul> 
<p><b>KB110CA0/2</b></p> <p><b>KB110CA0/3</b></p> <ul style="list-style-type: none"> <li>• Kit scorrevole parete/soffitto con retainer e antishock.</li> <li>• Kit corredizo de pared / techo con retenedor y Antishock</li> <li>• Sliding wall / ceiling kit with retainer and Antishock</li> <li>• KSchiebewand- / Deckensatz mit Halter und Antishock</li> <li>• Kit mur / plafond coulissant avec retenue et Antishock</li> </ul> 	<p><b>KB110SA0/2</b></p> <p><b>KB110SA0/3</b></p> <ul style="list-style-type: none"> <li>• Kit scorrevole su vetro fisso con retainer e antishock.</li> <li>• Kit corredizo sobre vidrio fijo con retenedor y Antishock</li> <li>• Sliding kit on fixed glass with retainer and Antishock</li> <li>• Schiebesatz auf festem Glas mit Halter und Antishock</li> <li>• Kit coulissant sur verre fixe avec retenue et Antishock</li> </ul>  <p>5x KB110SA0/2 7x KB110SA0/3</p>	<p><b>KB110FA0/2</b></p> <p><b>KB110FA0/3</b></p> <ul style="list-style-type: none"> <li>• Kit scorrevole a soffitto con fisso, con retainer e antishock.</li> <li>• Kit de techo corredizo con fija, con retenedor y Antishock</li> <li>• Sliding ceiling kit with fixed, with retainer and Antishock</li> <li>• Schiebedecken-Kit mit fester, mit Halter und Antishock</li> <li>• Kit plafond coulissant avec fixe, avec retenue et Antishock</li> </ul> 



# FLUIDO+ 110- KIT PINZE

Clamps kit

## B110EK10



- Kit coppia pinze con chiave
- Kit par de pinzas con llave
- Kit with pair of clamps with key
- Bausatz ein Paar Zangen mit Schlüssel
- Kit paire de pinces avec clé

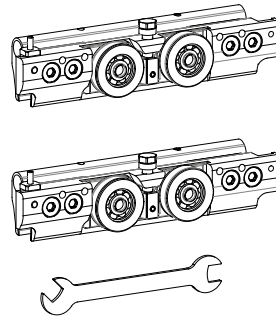

## B150EK3NN



- Kit coppia Retainer. Stop meccanico
- Kit par tope mecánico
- Kit with pair of mechanical stops
- Bausatz ein Paar mechanische Stopper
- Kit paire arrêt mécanique

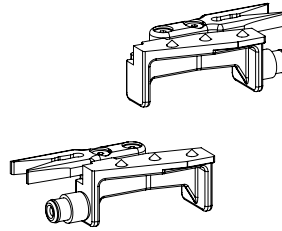

## B150EK3AA



- Kit coppia Retainer + Antishock
- Kit par tope mecánico + antichoque
- Kit with pair of mechanical stops and anti-shock feature
- Bausatz ein Paar mechanische Stopper + Antishock
- Kit paire arrêt mécanique + butée antichoc

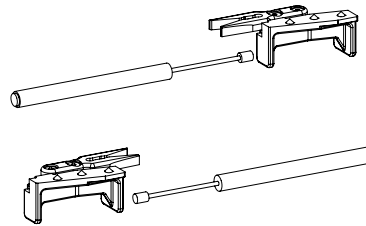

## B110EK3SS



- Kit coppia Soft Close CPCS
- Kit par Soft Close CPCS
- Kit with Soft Close CPCS pair
- Bausatz ein Paar Soft Close CPCS
- Kit paire Soft Close CPCS

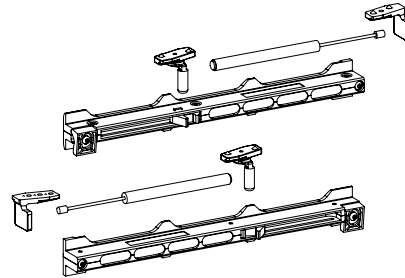

## B110EP73

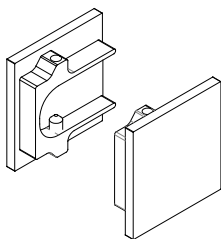

- Coppia di tappi.
- Par de tapones
- Pair of caps
- Paar Kappen
- Paire de bouchons

## B110EP74

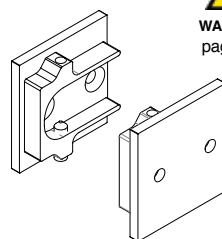

- Coppia di tappi forati.
- Par de tapones perforados
- Pair of perforated caps
- Paar Lochkappen
- Paire de bouchons perforés

## B110EP75

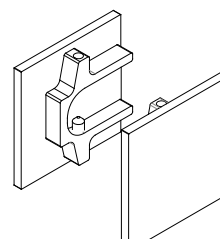

- Coppia di tappi per versione con fisso laterale.
- Par de tapones para versión con cristal fijo lateral
- Pair of caps for model with side fixed glass
- Paar Kappen für Version mit festem Seitenglas
- Paire de bouchons pour version avec vitrage fixe latéral

## B110EP76

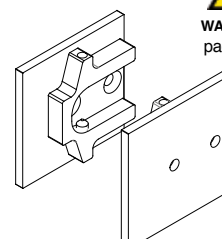

- Coppia di tappi forati per versione con fisso laterale.
- Par de tapones perforados para versión con cristal fijo lateral
- Pair of perforated caps for model with side fixed glass
- Paar Lochkappen für Version mit festem Seitenglas
- Paire de bouchons perforés pour version avec vitrage fixe latéral

# FLUIDO+ 110 - COMPONENTI

## Components

### B110EP64

- Spessore per Veletta - Consigliato per binari oltre i 2,5m
- Cuña para panel - Aconsejado para perfiles de largo superior a 2,5 m
- Spacer for casing - Recommended for rails longer than 2,5 m
- Distanzstück für Anlauf - Empfohlen für Profilen über 2,5 m
- Épaisseur pour panneau - Recommandé pour les profils de plus de 2,5 m

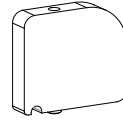

### B110EP77



**WARNING**  
pag. 326

- Coppia supporti laterali
- Par de soportes laterales
- Pair of side fittings
- Paar Seitenträger
- Paire de supports latéraux

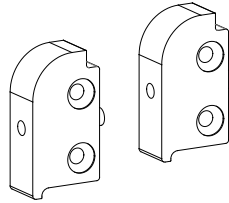

### B150EP48

- Tassello di collegamento - per vetro fisso
- Pieza de unión - para cristal fijo
- Connection insert - for fixed glass
- Verbindungsdübel - für festem Glas
- Tasseau d'assemblage - pour vitrage fixe

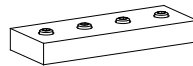

### BF50

- Guida a terra.
- Guía de suelo
- Ground slide
- Bodenführung
- Guide au sol

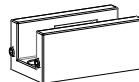

### B150EP85

- Kit accessorio per porte in legno.
- Kit accesorios para puertas de madera.
- Accessory kit for wooden doors.
- Zubehörkit für Holztüren.
- Kit accessoires pour portes en bois.

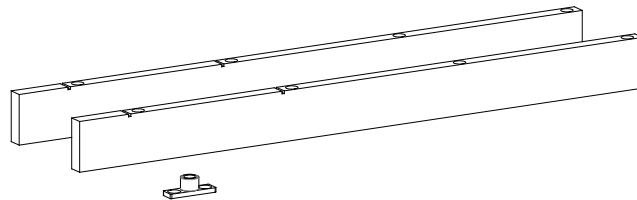

### BF70

- Borchia per fissaggio barra a vetro.
- Perno de fijación de la barra al cristal
- Boss for securing glass bar
- Senkschraube zur Befestigung der Stange am Glas
- Clou de fixation de la barre à la vitre

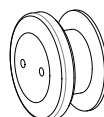

#### Lunghezza barra

Longitud de la barra  
Bar length  
Profililänge  
Longueur de barre

#### Quantità borchie

Cantidad tornillos  
Quantity of studs  
Anzahl der Stifte  
Quantité

2 mt	5
3 mt	7
3,2 mt	8
4 mt	10
6 mt	15

# B150EP27

- Perno per porte battenti da applicare ad estrusi Fluido+.
- Pernio para puertas batientes, por aplicar a perfiles Fluido+.
- Spindle for swing doors, to be applied to Fluido+ profiles.
- Drehpunkt für Pendeltüren für Fluido+ Profilen.
- Pivot pour portes battantes à appliquer sur profils Fluido+.

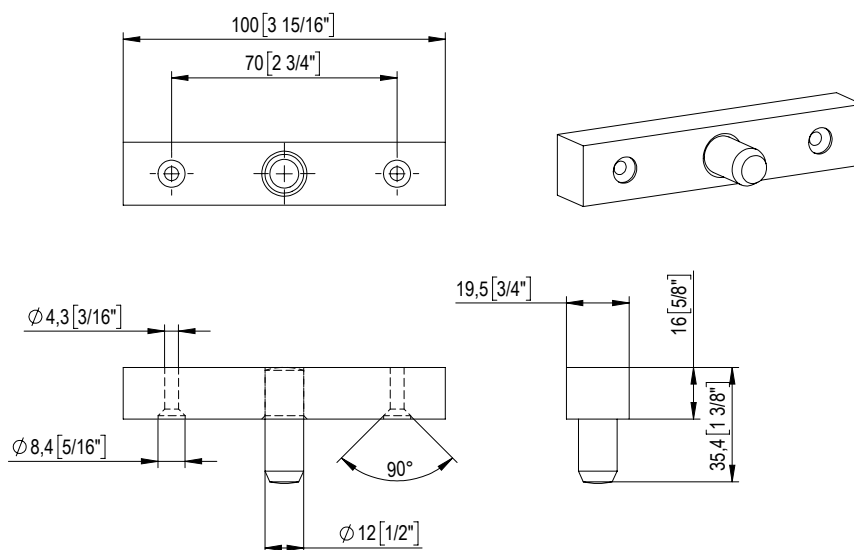

## ESEMPIO APPLICAZIONE CON CERNIERA UNICA 101E10 - 100E20

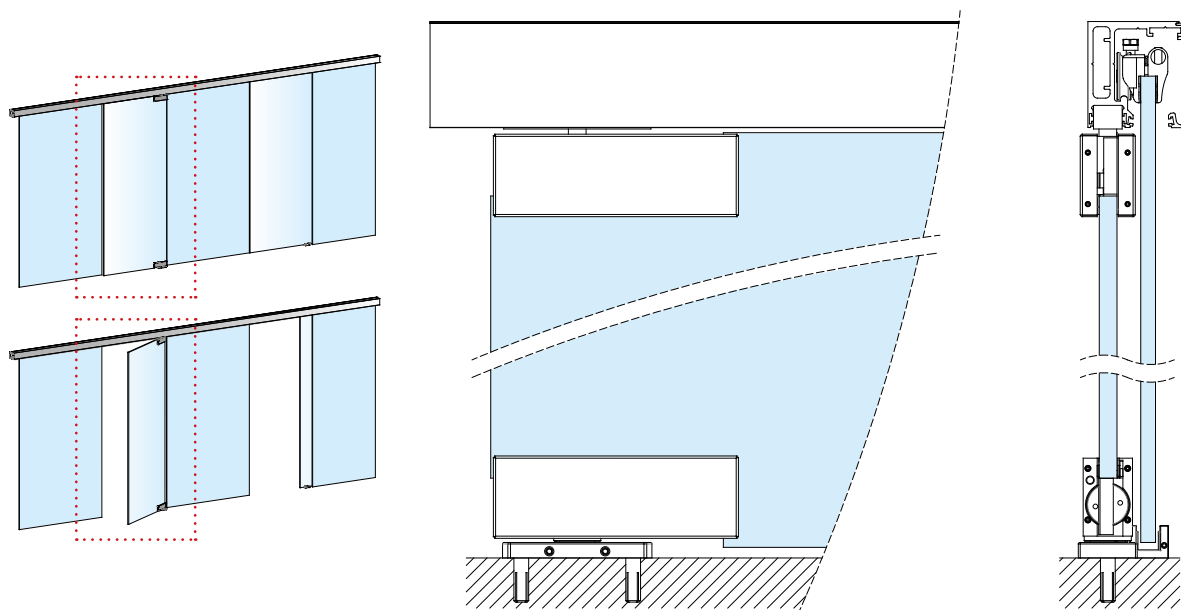

### WARNING

Con porta in chiusura/apertura contro il muro, è necessario tagliare il vetro come da disegno (per B110EP74 - B110EP76 - B110EP77)

With door closing/opening against the wall, it is necessary to cut the glass as per drawing (only B110EP74 - B110EP76 - B110EP77)

LE POSIZIONI DI STOP E PINZE DEVONO FARE RIFERIMENTO A QUESTO PUNTO

THE POSITIONS OF STOP AND CLAMPS MUST REFER TO THIS POINT

