

FLUIDO+ 150 PORTE IN VETRO - GLASS DOORS

Soluzioni - Solutions

SCORREVOLE A SOFFITTO

Sliding on Ceiling

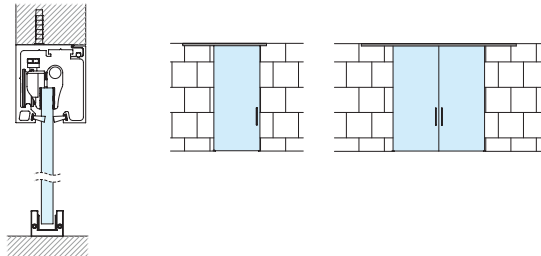

SCORREVOLE A PARETE

Sliding on Wall

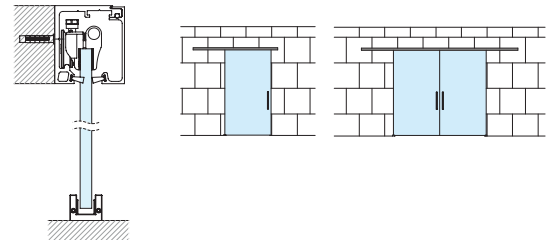

SCORREVOLE SU VETRO FISSO

Sliding on Sidelight

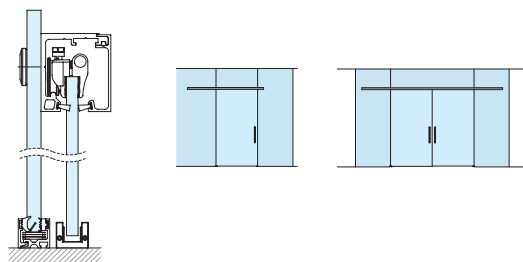

SCORREVOLE A SOFFITTO CON FISSO

Sliding on Ceiling with Sidelight

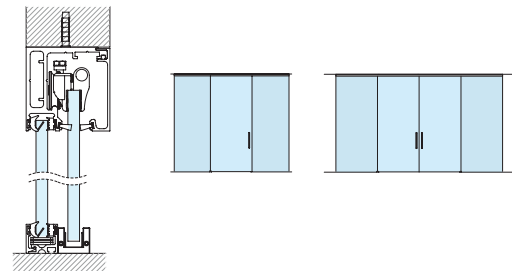

SCORREVOLE A FALSO SOFFITTO

Sliding on False Ceiling

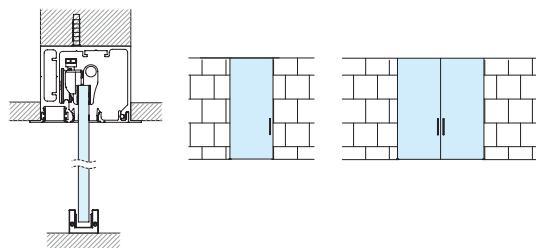

SCORREVOLE A FALSO SOFFITTO CON FISSO

Sliding on False Ceiling with Sidelight

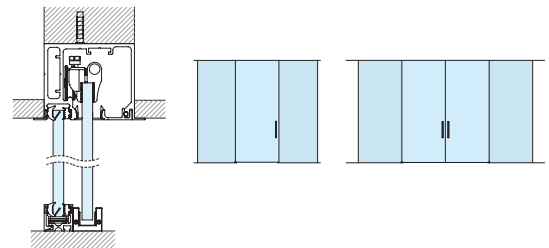

FLUIDO+ 150 PORTE IN VETRO - GLASS DOORS

Caratteristiche Tecniche Profili - Profiles Technical Characteristics

SCORREVOLE A SOFFITTO

Sliding on Ceiling

67 x 60 mm

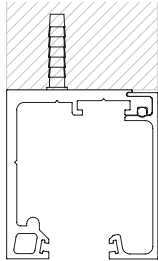

SCORREVOLE A PARETE

Sliding on Wall

67 x 60 mm

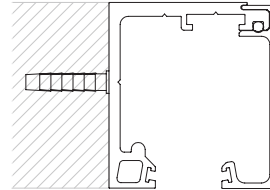

SCORREVOLE SU VETRO FISSO

Sliding on Sidelight

67 x 60 mm

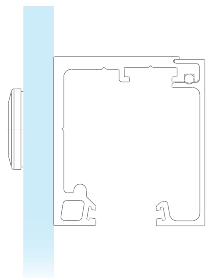

SCORREVOLE A SOFFITTO CON FISSO

Sliding on Ceiling with Sidelight

72 x 72 mm

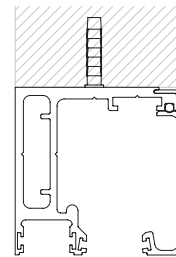

SCORREVOLE A FALSO SOFFITTO

Sliding on False Ceiling

85,4 x 72 mm

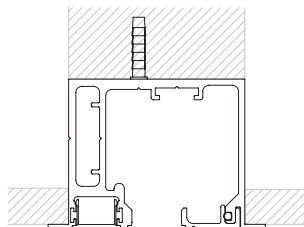

SCORREVOLE A FALSO SOFFITTO CON FISSO

Sliding on False Ceiling with Sidelight

85,4 x 72 mm

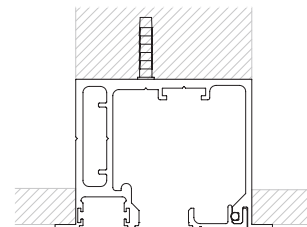

FLUIDO+ 150 PORTE IN LEGNO - WOODEN DOORS

Soluzioni - Solutions

SCORREVOLE A SOFFITTO - PORTA IN LEGNO

Sliding on Ceiling - Wooden Door

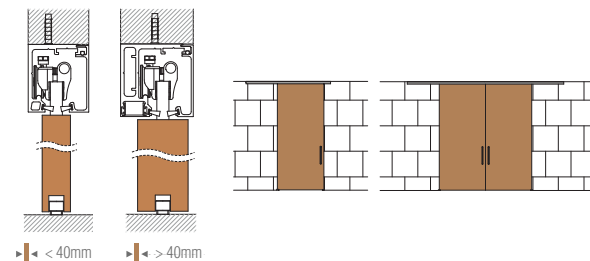

SCORREVOLE A PARETE - PORTA IN LEGNO

Sliding on Wall - Wooden Door

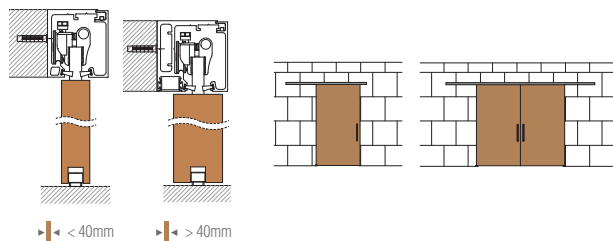

SCORREVOLE A SOFFITTO - PORTA IN LEGNO CON FISSO

Sliding on Ceiling - Wooden Door with Sidelight

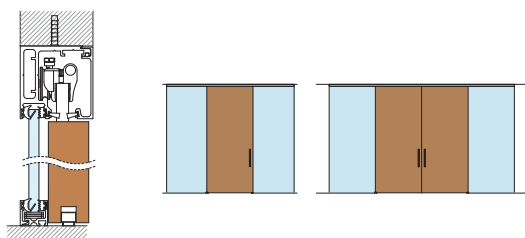

FLUIDO+ 150 PORTE IN LEGNO - WOODEN DOORS

Caratteristiche Tecniche Profili - Profiles Technical Characteristics

SCORREVOLE A SOFFITTO - PORTA IN LEGNO

Sliding on Ceiling - Wooden Door

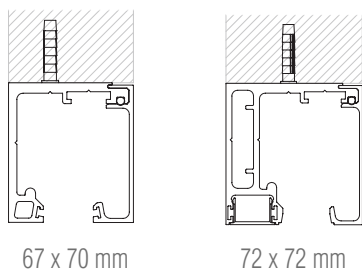

SCORREVOLE A PARETE - PORTA IN LEGNO

Sliding on Wall - Wooden Door

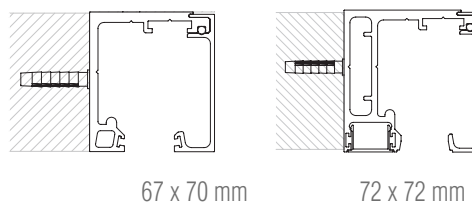





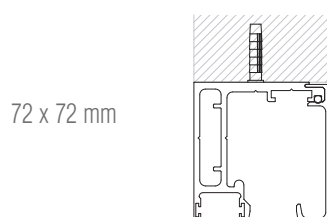











SCORREVOLE A SOFFITTO - PORTA IN LEGNO CON FISSO

Sliding on Ceiling - Wooden Door with Sidelight



FLUIDO+ 150 - Dettagli Tecnici

Technical details

 PORTATA Weight	150kg per porta / for door 330lbs		
 SPESSORE VETRO Glass thickness	10 ÷ 14 mm 3/8" to 9/16"		
 SPESSORE PORTA IN LEGNO Wooden door thickness	28 ÷ 50 mm 1 1/8" to 1 15/16"		
 REGOLAZIONE IN ALTEZZA Height adjustment	6 mm 1/4"		
 DISTANZA A PARETE Wall distance	22 mm 7/8"		
 DISTANZA TRA ANTA E VETRO FISSO Distance between door and sidelight	15.4 ÷ 17.4 mm 5/8" to 11/16"		
 INSTALLAZIONE A VETRO Glass installation	✓		
 INSTALLAZIONE A FALSO SOFFITTO False ceiling installation	✓		
 INSTALLAZIONE TRA PARETI Installation between walls	✓		
 SOFTCLOSE Soft close	Doppio / Double		
 DIMENSIONI MINIME (doppio Softclose) Minimum dimensions (double soft close)	1014 mm 39 3/4"		
 ANTISHOCK Antishock	Doppio / Double		
 DIMENSIONI MINIME (doppio antishock) Minimum dimensions (double antishock)	800 mm 31 1/2"		
 RETAINER MECCANICO Mechanical retainer	Doppio / Double		
 DIMENSIONI MINIME (doppio Retainer) Minimum dimensions (double Retainer)	800 mm 31 1/2"		
 FINITURE Finishes	02 Ossidato naturale Natural oxidized	05 Ossidato nero Black oxidized	13 PVD simil inox similar PVD stainless steel



**CERTIFICAZIONE DURABILITÀ
CICLI CORROSIONE**
Durability certification
Corrosion cycles

DURABILITÀ (100.000 Cicli)
Durability (100.000 Cycles)

PESO DELLA PORTA (da 101 a 330 kg)
Door mass (from 101 up to 330 kg)

SICUREZZA (Grado 1 per tutti gli scorrevoli)
Safety (All sliding must be grade 1)

RESISTENZA ALLA CORROSIONE (Alta resistenza)
Corrosion resistance (High resistance)

CATEGORIA DELLA PORTA (Porta scorrevole)
Category of door (Sliding door)

FRIZIONE INIZIALE VALORE MASSIMO CONSENTITO (4% della massa)
Initial friction maximum permitted value (4% of the mass)

according to

EN1527

- 6 3 - 1 3 - 1 3

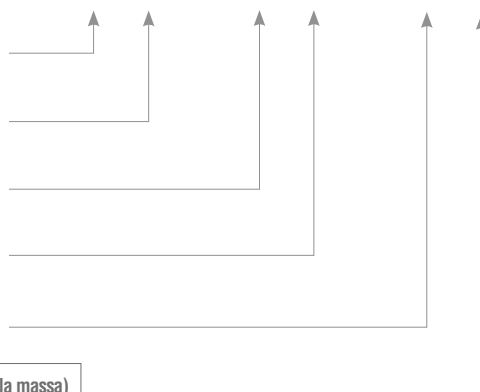

FLUIDO+ 150

scorrevole a soffitto con fisso
sliding on ceiling with sidelight

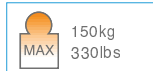
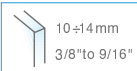

- Profili per scorrevole
- fissaggio a soffitto con vetro fisso.
- Perfil para sistema corredero
- fijación a techo con vidrio fijo.
- Profiles for sliders
- fixed on ceiling with fixed glass.
- Schiebesystem Fluido
- Befestigung an Decke mit Seitenteilen aus Glas.
- Profils pour coulissant
- fixation au plafond avec verre fixe.

LUNGHEZZE PROFILI - LENGTH OF PROFILES

- B150EK01/2 (2 mt)
- B150EK01/3 (3 mt)
- B150EK01/3.2 (3.2 mt)
- B150EK01/4 (4 mt)
- B150EK01/6 (6 mt)

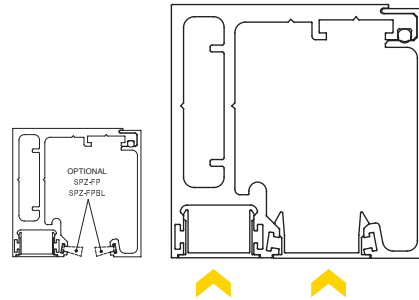

OPTIONAL

guarnizione a spazzola
brush seal

FINITURE / COLORS: 02-13

- SPZ-FP/4 (4mt)
- SPZ-FP/6 (6mt)
- SPZ-FP/6.4 (6.4mt)
- SPZ-FP/8 (8mt)
- SPZ-FP/12 (12mt)

FINITURA / COLOR: 05

- SPZ-FPBL/4 (4mt)
- SPZ-FPBL/6 (6mt)
- SPZ-FPBL/6.4 (6.4mt)
- SPZ-FPBL/8 (8mt)
- SPZ-FPBL/12 (12mt)

- B150EP45/2 (2mt)
- B150EP45/3 (3mt)
- B150EP45/3.2 (3.2mt)
- B0150EP45/4 (4mt)
- B150EP45/6 (6mt)

- B150EP46/2 (2mt)
- B150EP46/3 (3mt)
- B0150EP46/3.2 (3.2mt)
- B150EP46/4 (4mt)
- B150EP46/6 (6mt)

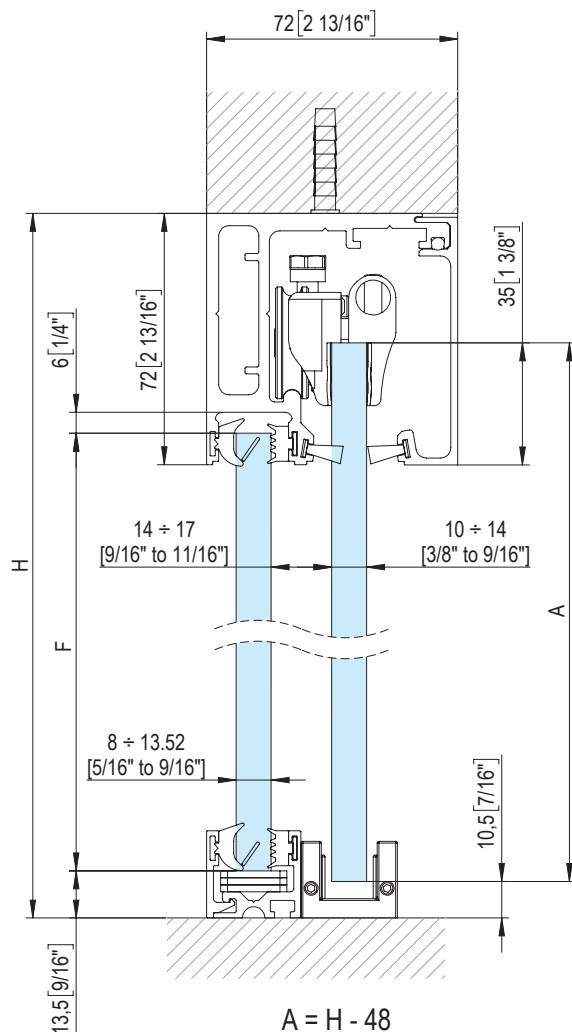
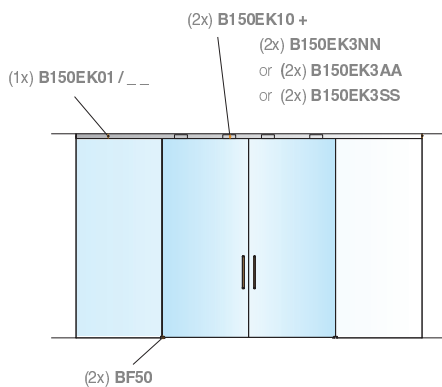
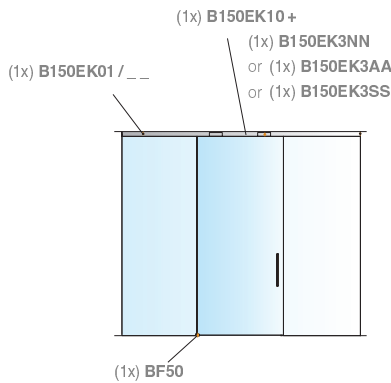

$$A = H - 48$$

$$[A = H - 1 7/8"]$$

$$F = H - 77$$

$$[F = H - 3 1/16"]$$

NON INCLUSI - NOT INCLUDED

P20EJ0810/6 P20EJ1113/6 P20E29/58

Vedere scheda catalogo P20E nella sezione PARTIZIONI
See P20E technical sheet in PARTITIONING section

L'installazione dei Fluido 70, 110 e 150 non necessita di forature sul vetro. La instalación del "Fluido 70, 110 y 150" no necesita agujeros en el cristal. The installation of Fluido 70, 110 and 150 does not need holes on the glass. Die Systeme Fluido 70, 110 und 150 benötigen keine Glasbearbeitung. L'installation des coulissants Fluido 70, 110 et 150 ne requiert pas de perçage du verre.