



We Build the Invisible

**SABCO**<sup>®</sup>

SADEV BALUSTRADE CONCEPT



## INSTALL IT FIT

### 1 CLADDING WITH SEAL

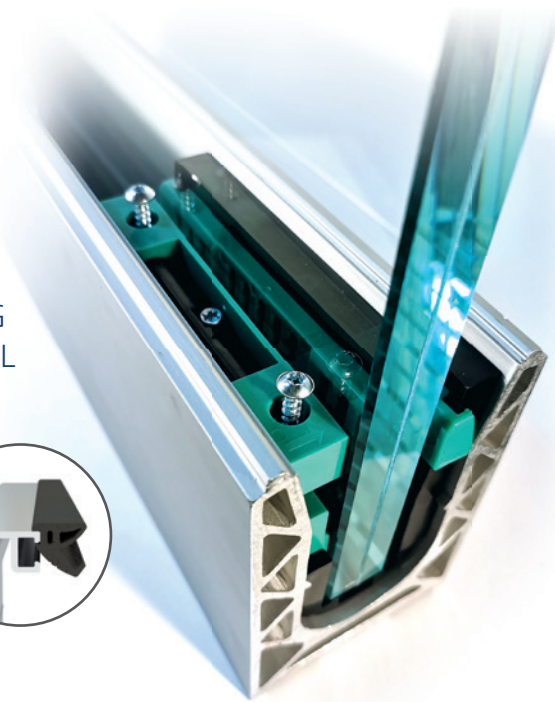
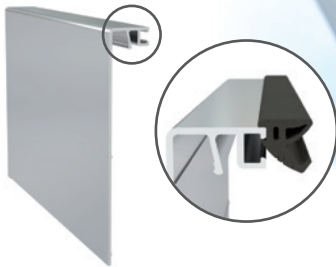

### 2 GLASS ADJUSTMENT

SABCO's wedge system aligns the glass for a quicker and easier installation.

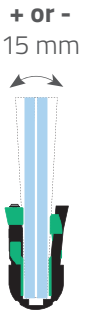

### 3 ONE SIDE ONE STEP!



Easy adjustment thanks to the clamps, no other installation requirements except tightening!

## WHICH SYSTEMS FOR YOUR PROJECTS?

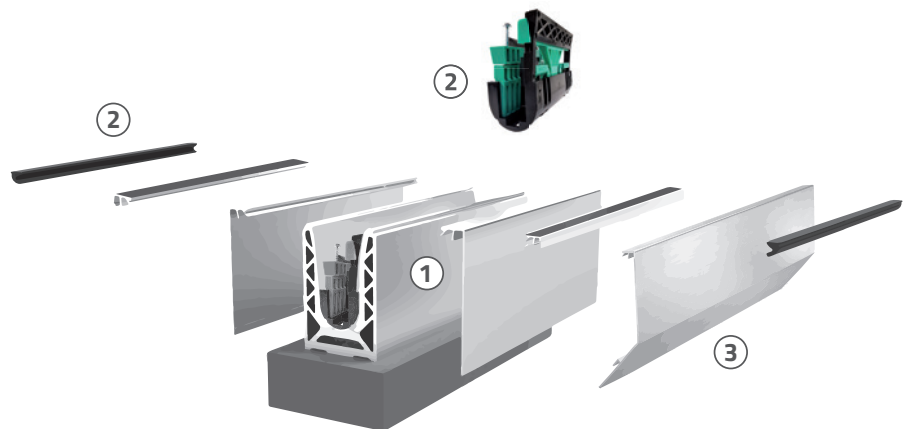

1

### CHOOSE YOUR BALUSTRADE

**For the installation of your glass balustrade, SADEV<sup>®</sup> is able to offer you a large choice of systems.**

To choose the right profile according to of your project, it is necessary to take taking into account these 3 criteria:

- A** the type of application
- B** the fixing surface
- C** the type of installation

2

### COMPLETE IT!

Once the profile has been selected, you must complete the assembly of your guardrail with the corresponding shims and joints.

Choose the shims according to the thickness of the glass.

The choice of joints will be made according to the shims used.

**All our accessories are tested and approved.**

3

### FINALIZE YOUR SOLUTION

Our engineers have developed a wide range of cladding to meet you specific project requirements.

SABCO's cladding range is compatible with one side and double side wedges as well as with our complete SABCO balustrade product range.

# MOUNTING TYPE

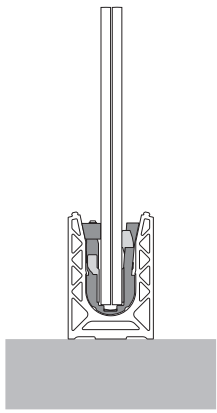

**FLOOR MOUNTING**

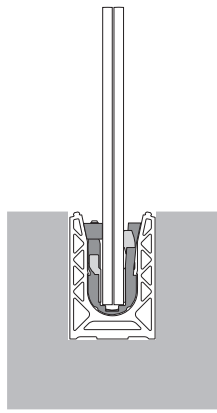

**BUILT-IN-SLAB**

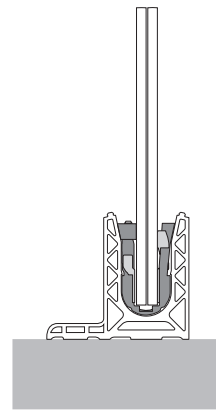

**OFFSET MOUNTING**

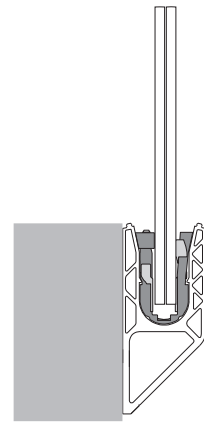

**LATERAL OFFSET FIXING**

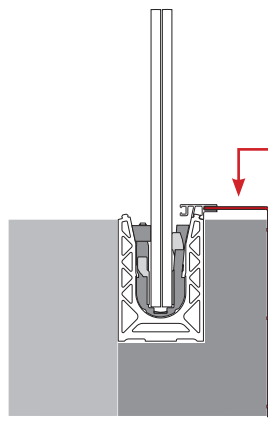
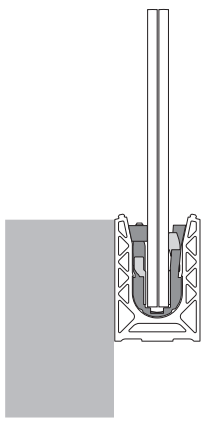

Cladding in addition

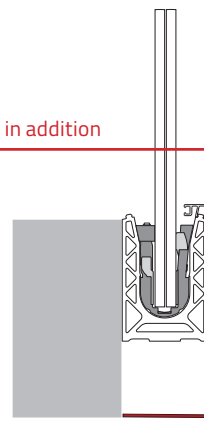

**LATERAL MOUNTING**

## FLOOR MOUNTING PROFIL

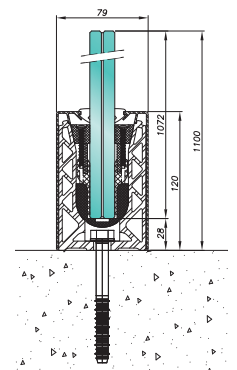

CAD files other profiles available upon request

# DIFFERENT TYPES OF APPLICATION

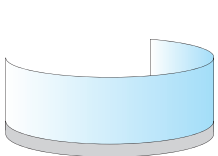

## CURVED

Curved railings. Bending is possible from a minimum radius of 1 metre.

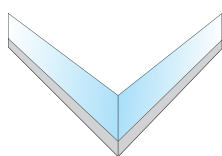

## TAILOR MADE

Adapts to even the tightest corners.

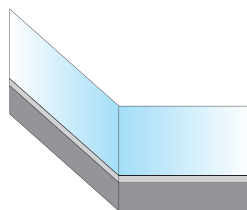

## INCLINE

Up to 40° angle to the horizontal.



## OVERSIZE

Suitable for high glasses, above of 1.1m

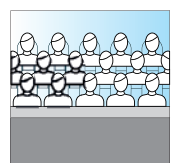

## HEAVY DUTY

C5 / UEFA stadium and high performance application

# CUSTOM YOUR FINISH

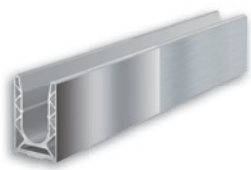

## ANODIZED ALUMINUM

Anodizing is an electrolyte process used to increase the thickness of the natural oxide layer.

**The process provides better corrosion and wear resistance to aluminum products.**



## BRUSHED STEEL EFFECT ALUMINUM

Brushed or dull polished metal with a unidirectional satin finish.

It is produced by polishing the metal with a 120-180 grit belt or wheel then finishing with an 80-120 grit greaseless compound or medium non-woven-abrasive belt or pad.

*Finishing possible on profiles and claddings*



## RAL

RAL is a European color matching system. It defines colors for paint, coatings and plastics.

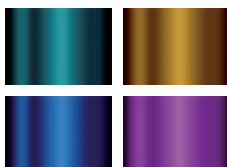

**RAL Effect** includes 420 solid colors and in particular 70 metallic colors.

*Finishing possible on profiles and claddings*



## WOOD SPECIAL

Made by SADEV

*Finishing possible on claddings*

# LIGHT UP YOUR BALUSTRADE

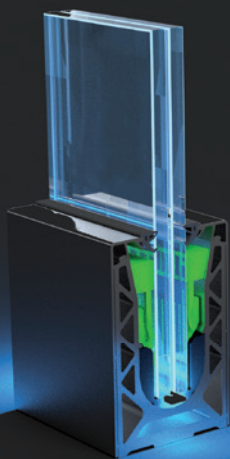

Enhance your project and its appearance **by adding lighting.**

We propose the full kit accessories with waterproof LED lighting in different colours to light up your balustrade.



We Build the Invisible

Tel. +33(0) 4 50 08 39 00 | Fax. +33(0) 4 50 08 39 49  
76, chemin des poses - 74330 Poisy (France)

sadev.com

follow us on



webuildtheinvisible.com

follow us on

