

# FLUIDO+ 150

MAX 150 Kg - 330 lbs

Porte - Doors

## PORTE IN VETRO / GLASS DOORS Soluzioni e Profili - Solutions and Profiles

### SCORREVOLE A SOFFITTO

Sliding on Ceiling

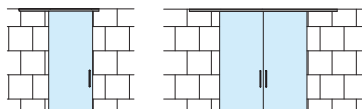
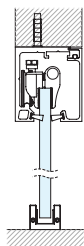

67 x 60 mm

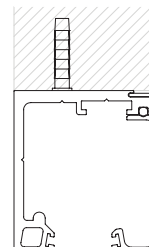

### SCORREVOLE A PARETE

Sliding on Wall

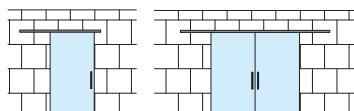
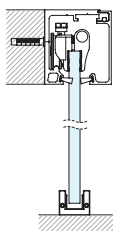

67 x 60 mm

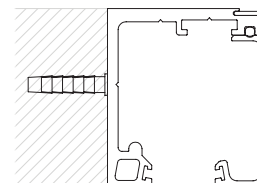

### SCORREVOLE SU VETRO FISSO

Sliding on Sidelight

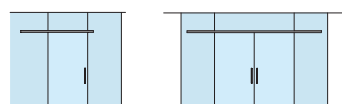
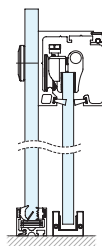

67 x 60 mm

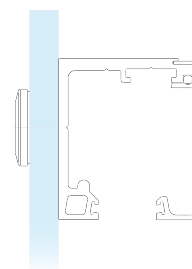

### SCORREVOLE A SOFFITTO CON FISSO

Sliding on Ceiling with Sidelight

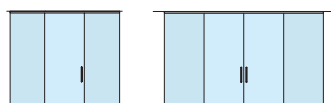
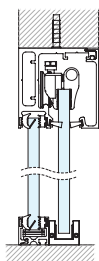

72 x 72 mm

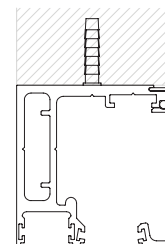

**FLUIDO+ 150**

MAX 150 Kg - 330 lbs

Porte - Doors

**PORTE IN VETRO / GLASS DOOR** Soluzioni e Profili - Solutions and Profiles**SCORREVOLE A FALSO SOFFITTO**

Sliding on False Ceiling

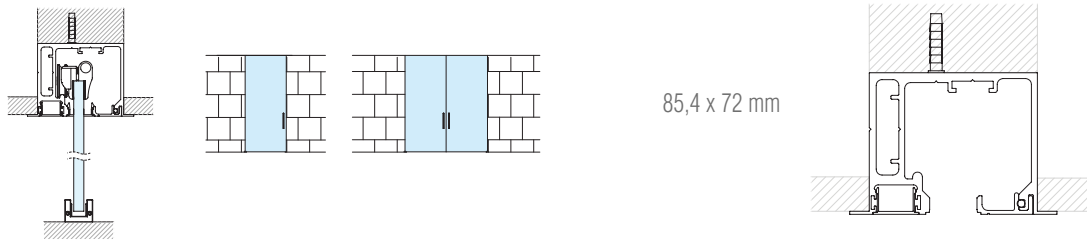



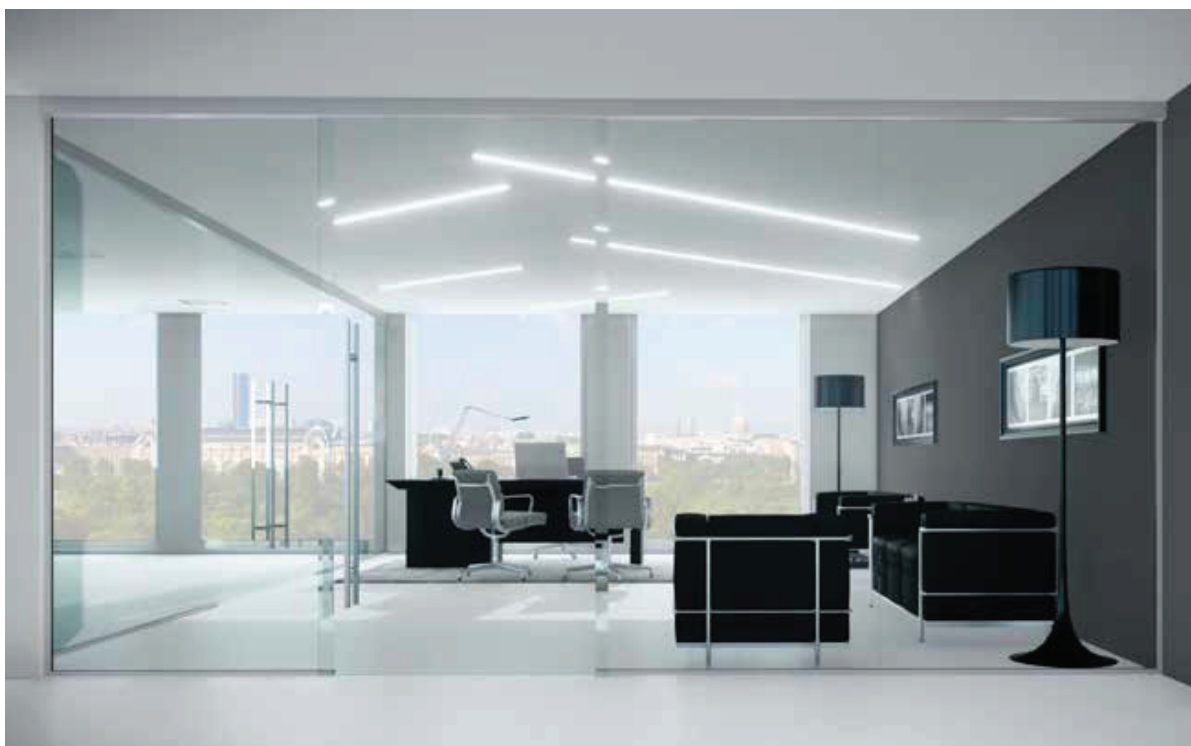
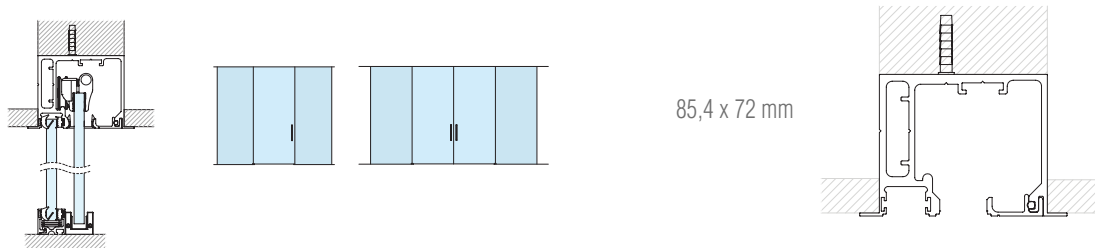











**SCORREVOLE A FALSO SOFFITTO CON FISSO**

Sliding on False Ceiling with Sidelight

SCORREVOLI  
SLIDING

## FLUIDO+ 150

## Dettagli Tecnici - Technical details

	<b>PORTATA</b> Weight	150kg per porta / for door 330lbs		
	<b>SPESORE VETRO</b> Glass thickness	10 ÷ 14 mm 3/8" to 9/16"		
	<b>SPESORE PORTA IN LEGNO</b> Wooden door thickness	28 ÷ 50 mm 1 1/8" to 1 15/16"		
	<b>REGOLAZIONE IN ALTEZZA</b> Height adjustment	± 3 mm 1/8"		
	<b>DISTANZA A PARETE</b> Wall distance	22 mm 7/8"		
	<b>DISTANZA TRA ANTA E VETRO FISSO</b> Distance between door and sidelight	15.4 ÷ 17.4 mm 5/8" to 11/16"		
	<b>INSTALLAZIONE A VETRO</b> Glass installation	✓		
	<b>INSTALLAZIONE A FALSO SOFFITTO</b> False ceiling installation	✓		
	<b>INSTALLAZIONE TRA PARETI</b> Installation between walls	✓		
	<b>SOFTCLOSE</b> Soft close	Doppio / Double		
	<b>DIMENSIONI MINIME (doppio Softclose)</b> Minimum dimensions (double soft close)	1014 mm 39 3/4"		
	<b>ANTISHOCK</b> Antishock	Doppio / Double		
	<b>DIMENSIONI MINIME (doppio antishock)</b> Minimum dimensions (double antishock)	800 mm 31 1/2"		
	<b>RETAINER MECCANICO</b> Mechanical retainer	Doppio / Double		
	<b>DIMENSIONI MINIME (doppio Retainer)</b> Minimum dimensions (double Retainer)	800 mm 31 1/2"		
	<b>FINITURE</b> Finishes	<b>02</b> Ossidato naturale Natural oxidized	<b>05</b> Ossidato nero Black oxidized	<b>13</b> PVD simil inox similar PVD stainless steel



**CERTIFICAZIONE DURABILITÀ  
CICLI CORROSIONE**  
Durability certification  
Corrosion cycles

**DURABILITÀ (100.000 Cicli)**  
Durability (100.000 Cycles)

**PESO DELLA PORTA (da 101 a 330 kg)**  
Door mass (from 101 up to 330 kg)

**SICUREZZA (Grado 1 per tutti gli scorrevoli)**  
Safety (All sliding must be grade 1)

**RESISTENZA ALLA CORROSIONE (Alta resistenza)**  
Corrosion resistance (High resistance)

**CATEGORIA DELLA PORTA (Porta scorrevole)**  
Category of door (Sliding door)

**FRIZIONE INIZIALE VALORE MASSIMO CONSENTITO (4% della massa)**  
Initial friction maximum permitted value (4% of the mass)

according to  
**EN1527**

- 6 3 - 1 3 - 1 3

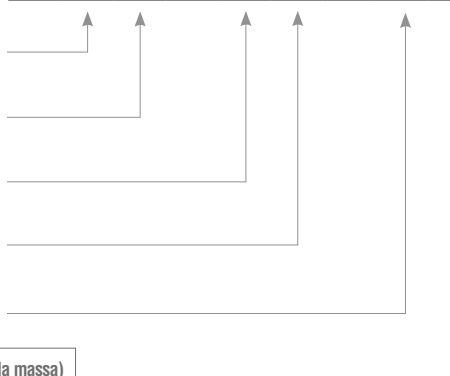

# FLUIDO+ 150 SU VETRO FISSO - ON SIDELIGHT

MAX 150 Kg - 330 lbs

Porte - Doors

**KB150SS0/3.2 = 3,2 m**

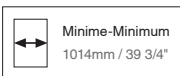

- Kit scorrevole su vetro fisso con doppio soft-close.
- Kit corredizo sobre vidrio fijo con doble Soft-close
- Sliding kit on fixed glass with double soft-close
- Schiebesatz auf festem Glas mit doppeltem Soft-Close
- Kit coulissant sur verre fixe avec double Soft-Close



TAPPI NON INCLUSI - CAPS NOT INCLUDED

★ Foro per BF70 - Hole for BF70 Ø 20 (13/16")

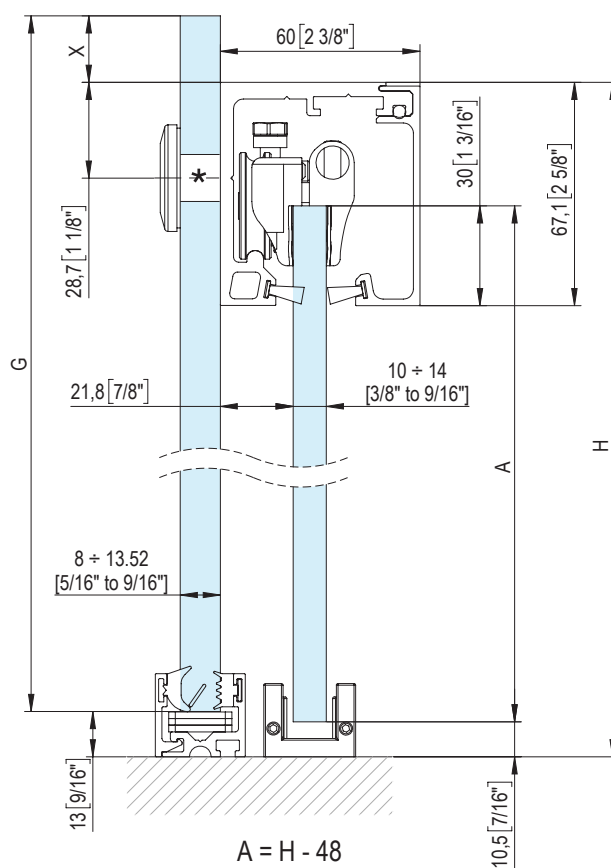

$$A = H - 48$$

$$[A = H - 1 7/8"]$$

$$G = H + X - 13$$

$$[G = H + X - 1/2"]$$

**NON INCLUSI - NOT INCLUDED**

P20EJ0810/6



P20EJ1113/6



P20E29/58



Vedere scheda catalogo P20E nella sezione PARTIZIONI  
See P20E technical sheet in PARTITIONING section



L'installazione dei Fluido+ 70, 110 e 150 non necessita di forature sul vetro • The installation of Fluido+ 70, 110 and 150 does not need holes on the glass

**FLUIDO+ 150**

## PROFILI BINARIO- PROFILES RAIL

MAX 150 Kg - 330 lbs



**B150EK00/2 ( 2 m )**  
**B150EK00/3 ( 3 m )**  
**B150EK00/3.2 ( 3,2 m )**  
**B150EK00/4 ( 4 m )**  
**B150EK00/6 ( 6 m )**

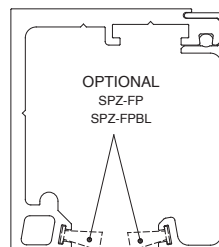

- Profilo binario per scorrevole: soffitto, parete e su vetro fisso.
- Perfil corredero para instalación a techo, pared y pared de vidrio.
- Sliding profile for ceiling, wall and sidelight installation.
- Schiebetürprofil für Decken-, Wand- und Glaswandeinbau.
- Profil de rail coulissant : plafond, mur et verre fixe.

**B150EK01/2 ( 2 m )**  
**B150EK01/3 ( 3 m )**  
**B150EK01/3.2 ( 3,2 m )**  
**B150EK01/4 ( 4 m )**  
**B150EK01/6 ( 6 m )**

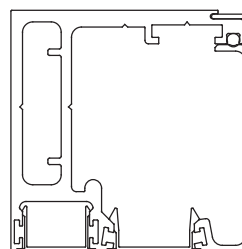
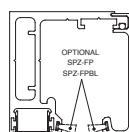

- Profilo binario per scorrevole a soffitto con vetro fisso
- Perfil corredero para instalación a techo con paño fijo.
- Sliding profile for ceiling with sidelight installation.
- Schiebetürprofil für Deckeneinbau mit seitlichen Glas.
- Profil coulissant de plafond avec verre fixe.

B150EP45/2 (2mt)  
 B150EP45/3 (3mt)  
 B150EP45/3.2 (3.2mt)  
 B0150EP45/4 (4mt)  
 B150EP45/6 (6mt)

OPTIONAL

B150EP46/2 (2mt)  
 B150EP46/3 (3mt)  
 B0150EP46/3.2 (3.2mt)  
 B150EP46/4 (4mt)  
 B150EP46/6 (6mt)

OPTIONAL

**B150EK02/2 ( 2 m )**  
**B150EK02/3 ( 3 m )**  
**B150EK02/3.2 ( 3,2 m )**  
**B150EK02/4 ( 4 m )**  
**B150EK02/6 ( 6 m )**

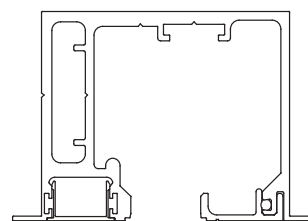

B150EP45/2 (2mt)  
 B150EP45/3 (3mt)  
 B150EP45/3.2 (3.2mt)  
 B0150EP45/4 (4mt)  
 B150EP45/6 (6mt)

OPTIONAL

- Profilo binario per scorrevole a falso soffitto e a falso soffitto con vetro fisso
- Perfil corredero para instalación a falso techo, con o sin paño fijo.
- Sliding profile for false ceiling installation, both with and without sidelight.
- Schiebetürprofil für Zwischendeckeneinbau, mit oder ohne seitlichen Glas.
- Profil coulissant de faux-plafond avec ou sans verre fixe.

# FLUIDO+ 150

## KIT PINZE- CLAMPS KIT

MAX 150 Kg - 330 lbs

Porte - Doors

### B150EK10



- Kit coppia pinze.
- Kit par de pinzas.
- Kit with pair of clamps.
- Bausatz ein Paar Zangen.
- Kit paire de pinces.

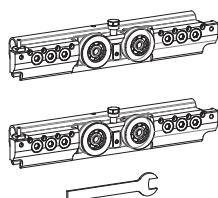

### B150EK05



- Kit coppia pinze falso soffitto
- Kit par de pinzas a cielo falso
- Kit with pair of clamps on false ceiling.
- Bausatz ein Paar Zangen an abgehängter Decke.
- Kit paire de pinces faux-plafond.

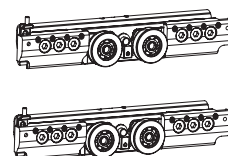

### B150EK3NN



- Kit coppia Retainer. Stop meccanico
- Kit par tope mecánico
- Kit with pair of mechanical stops
- Bausatz ein Paar mechanische Stopper
- Kit paire arrêt mécanique

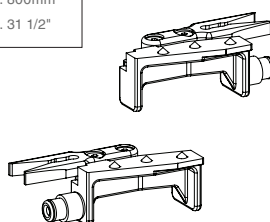

### B150EK3AA

- Kit coppia Retainer + Antishock
- Kit par tope mecánico + antichoque
- Kit with pair of mechanical stops and anti-shock feature
- Bausatz ein Paar mechanische Stopper + Antishock
- Kit paire arrêt mécanique + butée antichoc

### B150EK3SS

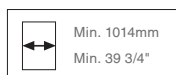

- Kit coppia Soft Close CPCS
- Kit par Soft Close CPCS
- Kit with Soft Close CPCS pair
- Bausatz ein Paar Soft Close CPCS
- Kit paire Soft Close CPCS

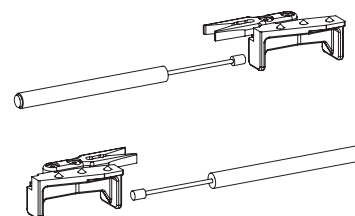
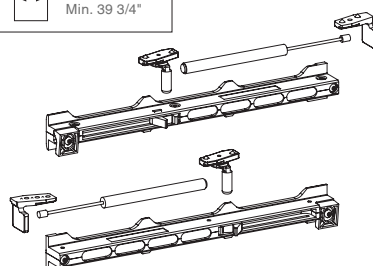

### B150EK66

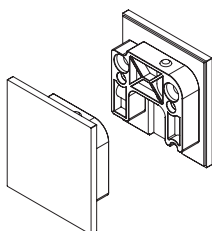

- Coppia di tappi.
- Par de tapones
- Pair of caps
- Paar Kappen
- Paire de bouchons

### B150EK67

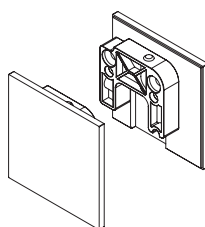

- Coppia di tappi per versione con fisso laterale.
- Par de tapones para versión con cristal fijo lateral
- Pair of caps for model with side fixed glass
- Paar Kappen für Version mit festem Seitenglas
- Paire de bouchons pour version avec vitrage fixe latéral

### B150EK68

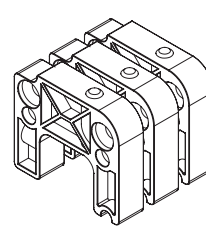

- Kit spessore per Veletta e supporti laterali - Consigliato per binari oltre i 2,5m
- Kit cuña para panel y soportes laterales - Aconsejado para perfiles de largo superior a 2,5 m
- Set spacer for casing and side fittings - Recommended for rails longer than 2,5 m
- Set Distanzstück für Anlauf und Seitenträger - Empfohlen für Profilen über 2,5 m
- Kit épaisseur pour panneau et supports latéraux - Recommandé pour les profils de plus de 2,5 m

## FLUIDO+ 150

## COMPONENTI- COMPONENTS

 150 Kg - 330 lbs

 Porte - Doors

## B150EP48

- Tassello di collegamento - per vetro fisso
- Pieza de unión - para cristal fijo
- Connection insert - for fixed glass
- Verbindungsdübel - für festem Glas
- Tasseau d'assemblage - pour vitrage fixe

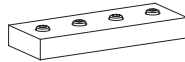

## BF50

- Guida a terra.
- Guía de suelo
- Ground slide
- Bodenführung
- Guide au sol

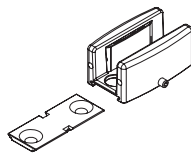

**SPZ-FP**  
**SPZ-FPBL**

- Guarnizione a spazzola in tessuto
- Guarnición de tela
- Fabric brush seal
- Stoffbürstendichtung
- Joint de brosse en tissu

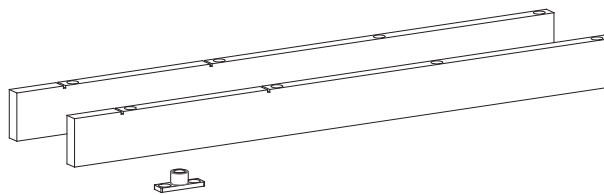

## B150EP85

- Kit accessorio per porte in legno.
- Kit accesorios para puertas de madera.
- Accessory kit for wooden doors.
- Zubehörkit für Holzüren.
- Kit accessoires pour portes en bois.



## BF70

- Borchia per fissaggio barra a vetro.
- Perno de fijación de la barra al cristal
- Boss for securing glass bar
- Senkschraube zur Befestigung der Stange am Glas
- Clou de fixation de la barre à la vitre

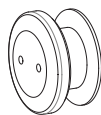

## Lunghezza barra

Longitud de la barra  
Bar length  
Profillänge  
Longueur de barre

## Quantità borchie

Cantidad tornillos  
Quantity of studs  
Anzahl der Stifte  
Quantité

Lunghezza barra	Quantità borchie
2 mt	5
3 mt	7
3,2 mt	8
4 mt	10
6 mt	15

**DETTAGLIO FORATURA FISSAGGIO A VETRO - DETAILS DRILLING FOR GLASS FIXING**

DETALLE AGUJERO PARA FIJACIÓN A VIDRIO - DETAIL DES BOHRENS FÜR DIE GLASFIXIERUNG - PLAN DE PERÇAGE POUR FIXATION SUR VERRE

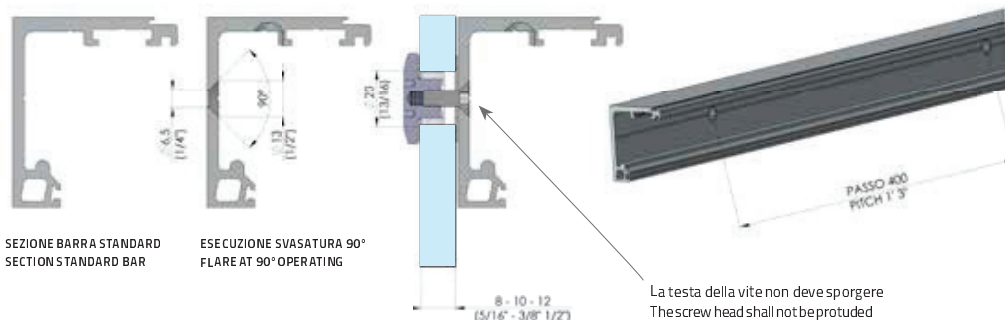

SEZIONE BARRA STANDARD  
SECTION STANDARD BAR

ESECUZIONE SVASATURA 90°  
FLARE AT 90° OPERATING

La testa della vite non deve sporgere  
The screw head shall not be protruded

## B150EP27 serie FLUIDO+



- Perno per porte battenti da applicare ad estrusi Fluido+.
- Pernio para puertas batientes, por aplicar a perfiles Fluido+.
- Spindle for swing doors, to be applied to Fluido+ profiles.
- Drehpunkt für Pendeltüren für Fluido+ Profilen.
- Pivot pour portes battantes à appliquer sur profils Fluido+.

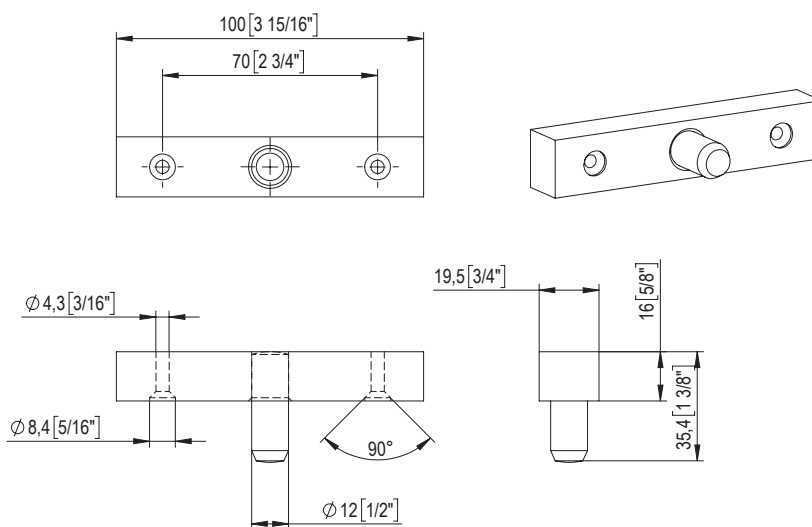

ESEMPIO APPLICAZIONE CON CERNIERA UNICA 101E10 - 100E20

