

5F20 FERMAVETRO QUADRO 45° BARRA REFUERZO - SECCIÓN CUADRADA 45°

1- FISSARE ATTACCO A MURO CON TASSELLO AD ESPANSIONE
FIJAR A LA PARED CON TACO DE EXPANSIÓN

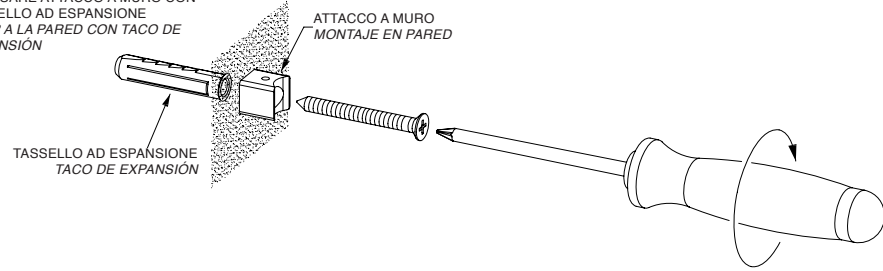

2- INSERIRE IL PERNO NELL'ATTACCO A MURO E CONTEMPORANEAMENTE IL TERMINALE SUL VETRO
INSERTE EL PERNO EN LA PARED Y ATACAR AL MISMO TIEMPO LA TERMINAL SOBRE EL VIDRIO

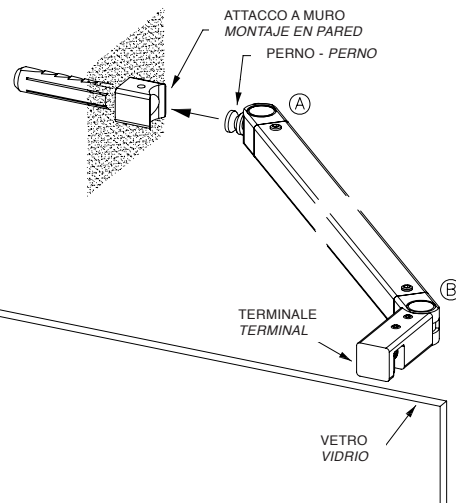

3- FISSARE LA BARRA AVVITANDO IL GRANO
FIJAR LA BARRA APRETANDO EL PRISONERO

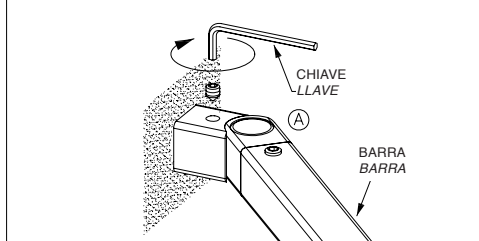

4- PINZARE IL VETRO AVVITANDO IL GRANO
SUJETE EL VIDRIO, APRETANDO EL PRISONERO

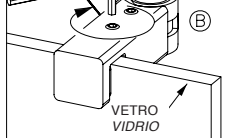

5- BLOCCARE LA POSIZIONE AVVITANDO IL GRANO
BLOQUEAR LA POSICIÓN, APRETANDO EL PRISONERO

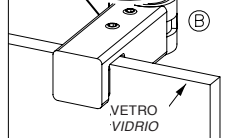

PERSONALIZZAZIONE LUNGHEZZA DELLA BARRA PERSONALIZACIÓN DE LA BARRA

A- SVITARE IL GRANO E RIMUOVERE IL TERMINALE
DESATORNILLAR EL PRISONERO Y QUITAR EL TERMINAL

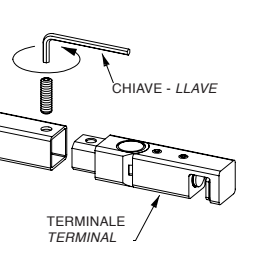

B- TAGLIARE TUBOLARE A MISURA DESIDERATA
REDUCIR EL TAMAÑO DEL TUBO

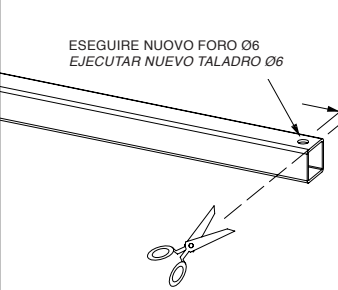

C- RIMONTARE IL TERMINALE AVVITANDO IL GRANO
VUELVA A MONTAR EL TERMINAL CON EL PRISONERO

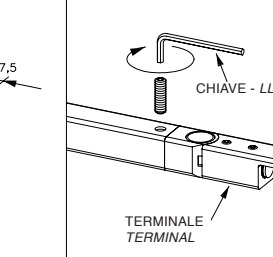

5F22 FERMAVETRO QUADRO BARRA REFUERZO - SECCIÓN CUADRADA

1- FISSARE ATTACCO A MURO CON TASSELLO AD ESPANSIONE
FIJAR A LA PARED CON TACO DE EXPANSIÓN

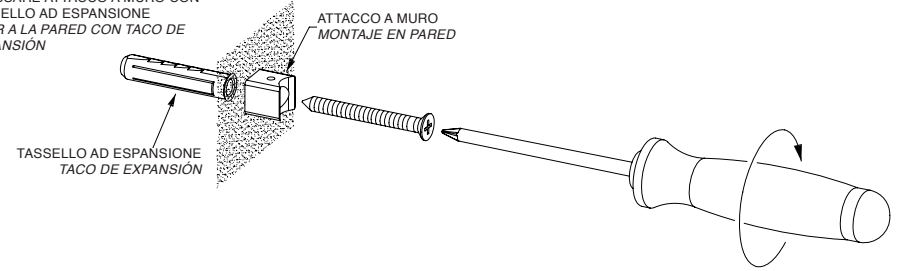

2- INSERIRE IL PERNO NELL'ATTACCO A MURO E CONTEMPORANEAMENTE IL TERMINALE SUL VETRO
INSERTE EL PERNO EN LA PARED Y ATACAR AL MISMO TIEMPO LA TERMINAL SOBRE EL VIDRIO



3- FISSARE LA BARRA AVVITANDO IL GRANO
FIJAR LA BARRA APRETANDO EL PRISONERO

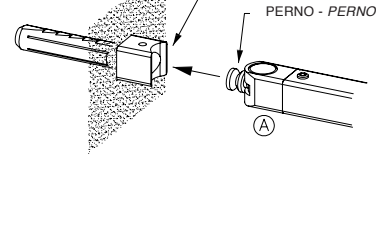

4- PINZARE IL VETRO AVVITANDO IL GRANO
SUJETE EL VIDRIO, APRETANDO EL PRISONERO

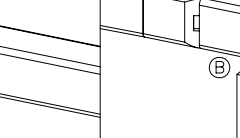

5- BLOCCARE LA POSIZIONE AVVITANDO IL GRANO
BLOQUEAR LA POSICIÓN, APRETANDO EL PRISONERO

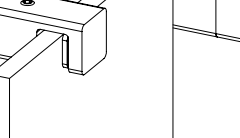

PERSONALIZZAZIONE LUNGHEZZA DELLA BARRA PERSONALIZACIÓN DE LA BARRA

A- SVITARE IL GRANO E RIMUOVERE IL TERMINALE
DESATORNILLAR EL PRISONERO Y QUITAR EL TERMINAL

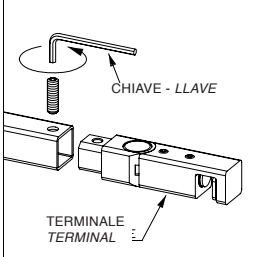

B- TAGLIARE TUBOLARE A MISURA DESIDERATA
REDUCIR EL TAMAÑO DEL TUBO

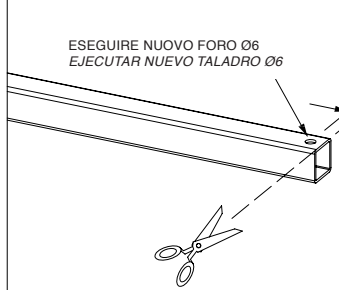

C- RIMONTARE IL TERMINALE AVVITANDO IL GRANO
VUELVA A MONTAR EL TERMINAL CON EL PRISONERO

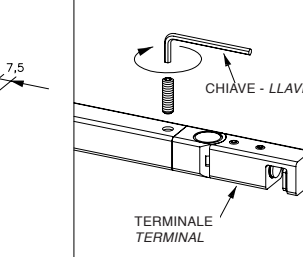

5F25 FERMAVETRO QUADRO 45° BARRA REFUERZO - SECCIÓN CUADRADA 45°

1- PINZARE IL VETRO AVVITANDO IL GRANO
SUJETE EL VIDRIO, APRETANDO EL PRISONERO

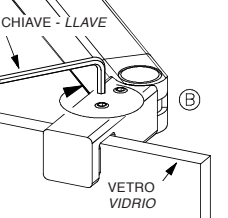

2- BLOCCARE LA POSIZIONE AVVITANDO IL GRANO
BLOQUEAR LA POSICIÓN, APRETANDO EL PRISONERO

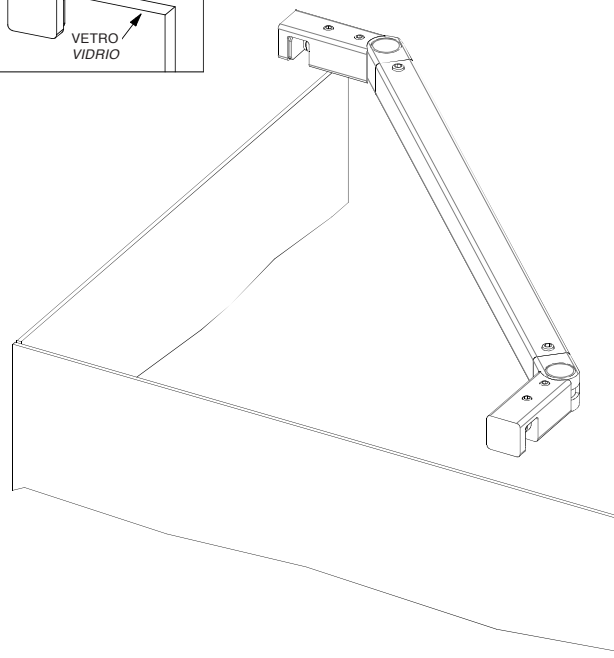
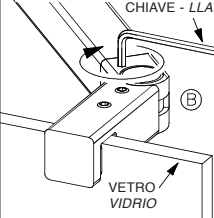

PERSONALIZZAZIONE LUNGHEZZA DELLA BARRA PERSONALIZACIÓN DE LA BARRA

A- SVITARE IL GRANO E RIMUOVERE IL TERMINALE
DESATORNILLAR EL PRISONERO Y QUITAR EL TERMINAL

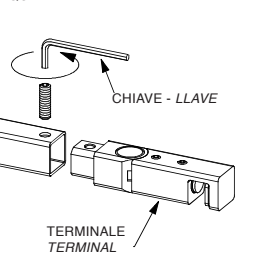

B- TAGLIARE TUBOLARE A MISURA DESIDERATA
REDUCIR EL TAMAÑO DEL TUBO

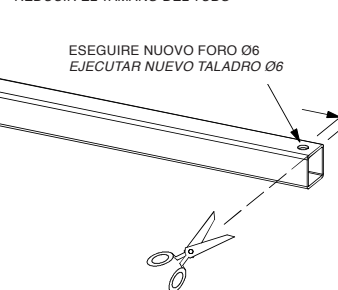

C- RIMONTARE IL TERMINALE AVVITANDO IL GRANO
VUELVA A MONTAR EL TERMINAL CON EL PRISONERO

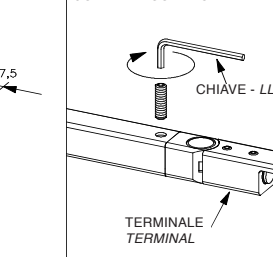

5F27 FERMAVETRO QUADRO BARRA REFUERZO - SECCIÓN CUADRADA

1- PINZARE IL VETRO AVVITANDO IL GRANO
SUJETE EL VIDRIO, APRETANDO EL PRISONERO

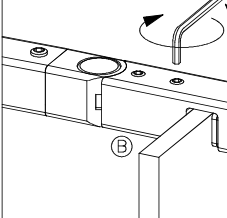

2- BLOCCARE LA POSIZIONE AVVITANDO IL GRANO
BLOQUEAR LA POSICIÓN, APRETANDO EL PRISONERO

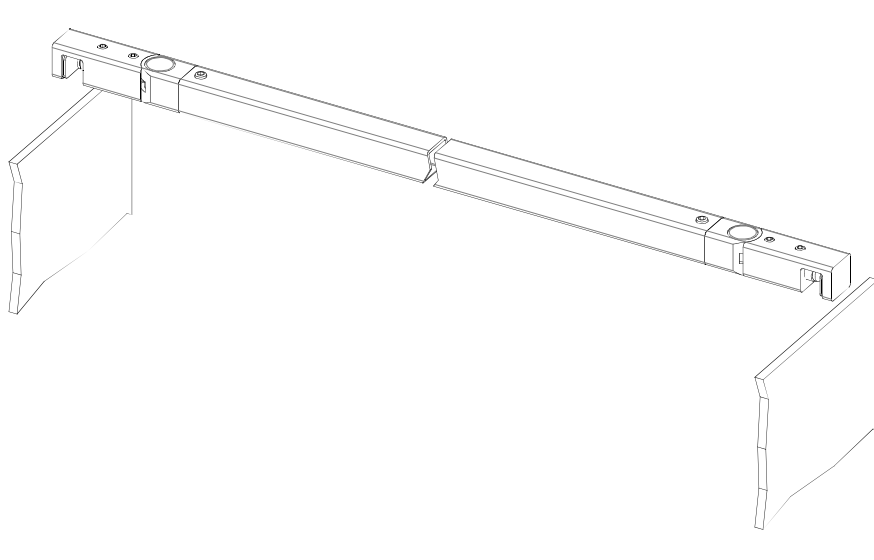
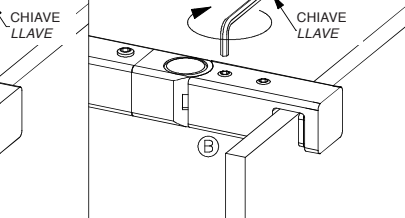

PERSONALIZZAZIONE LUNGHEZZA DELLA BARRA PERSONALIZACIÓN DE LA BARRA

A- SVITARE IL GRANO E RIMUOVERE IL TERMINALE
DESATORNILLAR EL PRISONERO Y QUITAR EL TERMINAL

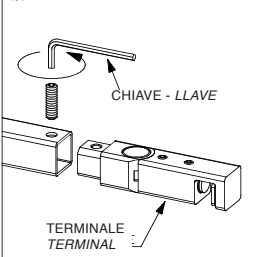

B- TAGLIARE TUBOLARE A MISURA DESIDERATA
REDUCIR EL TAMAÑO DEL TUBO

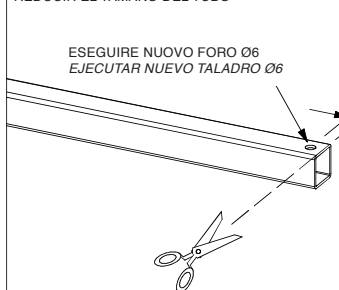

C- RIMONTARE IL TERMINALE AVVITANDO IL GRANO
VUELVA A MONTAR EL TERMINAL CON EL PRISONERO

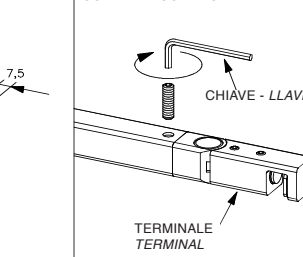

5F20 SQUARED STABILISING BAR 45° STABILISIERUNGSSTANGE BEI 45° - ROHR ECKIG

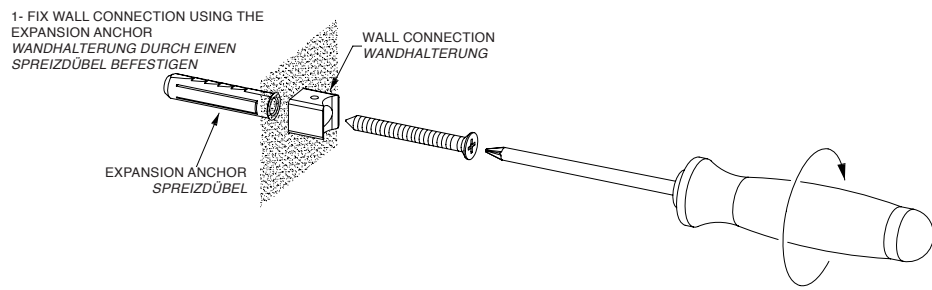

2- INSERT THE JUNCTION INTO THE WALL CONNECTION AND INSERT THE GLASS ENDING PART AT THE SAME TIME
DEN STIFT IN DIE WANDHALTERUNG EINFÜHREN UND GLEICHZEITIG DAS ENDETEIL AUF DAS GLAS EINSETZEN

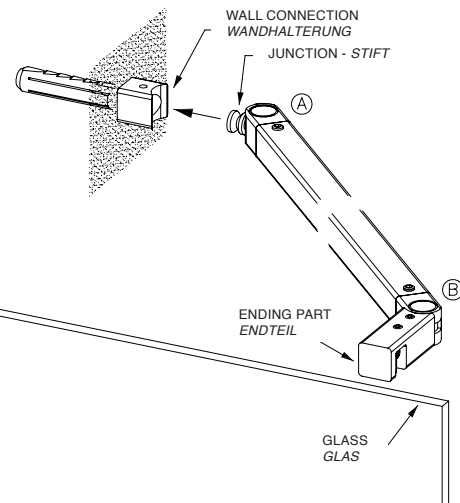

3- FIX THE BAR BY SCREWING THE DOWEL
DIE STANGE DURCH ANZIEHEN DER SCHRAUBE BEFESTIGEN

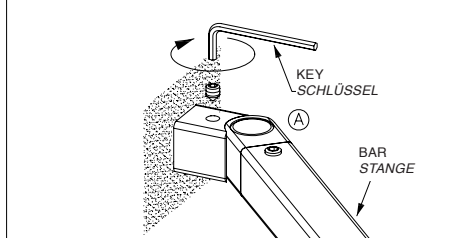

4- CLAMP THE GLASS BY SCREWING THE DOWEL - DAS GLAS WIRD DURCH ANZIEHEN DER SCHRAUBE GEKLEMMT

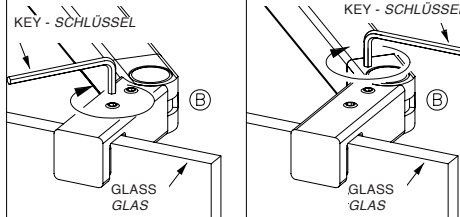

5- BLOCK THE POSITION BY SCREWING THE DOWEL - BLOCKIEREN DIESER POSITION ERFOLGT DURCH ANZIEHEN

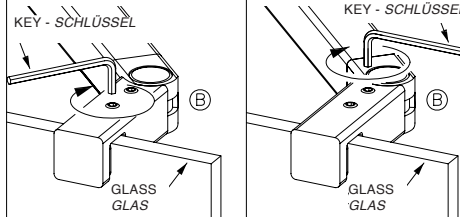

THE BAR'S LENGTH CAN BE CUSTOMIZED
DIE LÄNGE DER STANGE KANN INDIVIDUELLE ANGEPAST WERDEN

A- UNSCREW THE DOWEL AND REMOVE THE ENDING PART
DIE SCHRAUBE AUFSCHRAUBEN UND DAS ENDETEIL ENTFERNEN

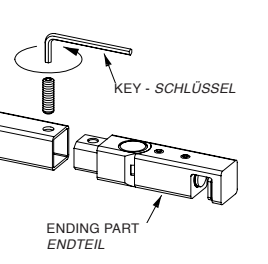

B- CUT THE TUBULAR AT THE DESIRED LENGTH
DAS ROHR AUF DIE GEWÜNSCHTE LÄNGE KÜRZEN

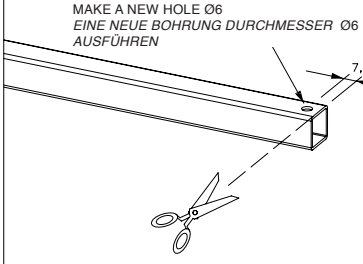

C- MOUNT THE ENDING PART AGAIN BY SCREWING THE DOWEL
DAS ENDETEIL DURCH ANZIEHEN DER SCHRAUBE WIEDER MONTIEREN

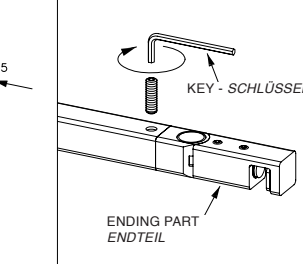

5F22 FERMAVETRO QUADRO BARRA REFUERZO - SECCIÓN CUADRADA

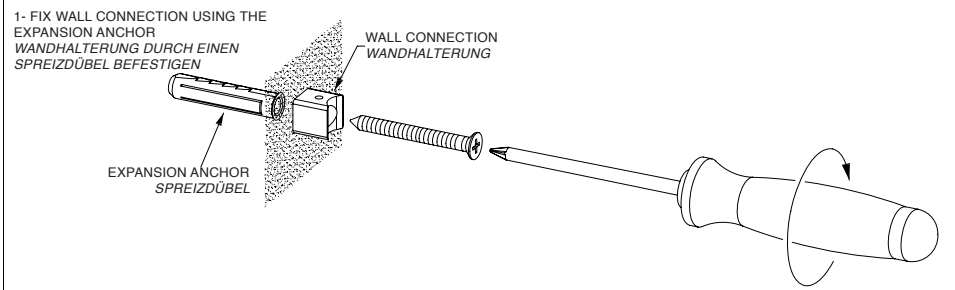

2- INSERT THE JUNCTION INTO THE WALL CONNECTION AND INSERT THE GLASS ENDING PART AT THE SAME TIME
DEN STIFT IN DIE WANDHALTERUNG EINFÜHREN UND GLEICHZEITIG DAS ENDETEIL AUF DAS GLAS EINSETZEN

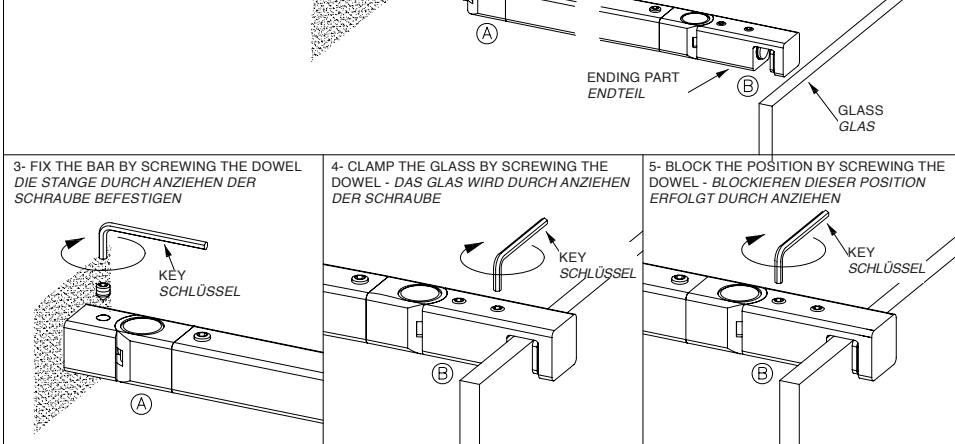

3- FIX THE BAR BY SCREWING THE DOWEL
DIE STANGE DURCH ANZIEHEN DER SCHRAUBE BEFESTIGEN

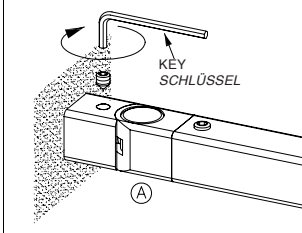

4- CLAMP THE GLASS BY SCREWING THE DOWEL - DAS GLAS WIRD DURCH ANZIEHEN DER SCHRAUBE

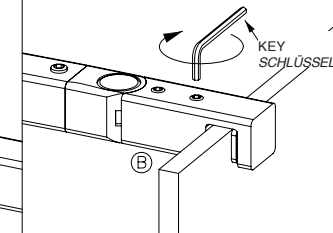

5- BLOCK THE POSITION BY SCREWING THE DOWEL - BLOCKIEREN DIESER POSITION ERFOLGT DURCH ANZIEHEN

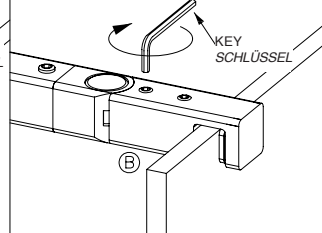

THE BAR'S LENGTH CAN BE CUSTOMIZED
DIE LÄNGE DER STANGE KANN INDIVIDUELLE ANGEPAST WERDEN

A- UNSCREW THE DOWEL AND REMOVE THE ENDING PART
DIE SCHRAUBE AUFSCHRAUBEN UND DAS ENDETEIL ENTFERNEN

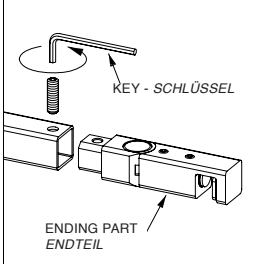

B- CUT THE TUBULAR AT THE DESIRED LENGTH
DAS ROHR AUF DIE GEWÜNSCHTE LÄNGE KÜRZEN

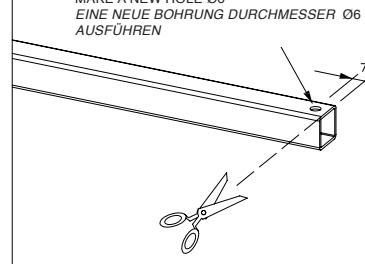

C- MOUNT THE ENDING PART AGAIN BY SCREWING THE DOWEL
DAS ENDETEIL DURCH ANZIEHEN DER SCHRAUBE WIEDER MONTIEREN

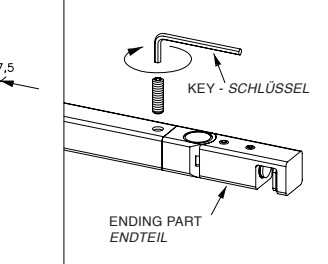

5F25 SQUARED STABILISING BAR 45° STABILISIERUNGSSTANGE BEI 45° - ROHR ECKIG

1- CLAMP THE GLASS BY SCREWING THE DOWEL
DAS GLAS WIRD DURCH ANZIEHEN DER SCHRAUBE

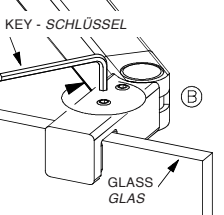

2- BLOCK THE POSITION BY SCREWING THE DOWEL
BLOCKIEREN DIESER POSITION ERFOLGT DURCH ANZIEHEN

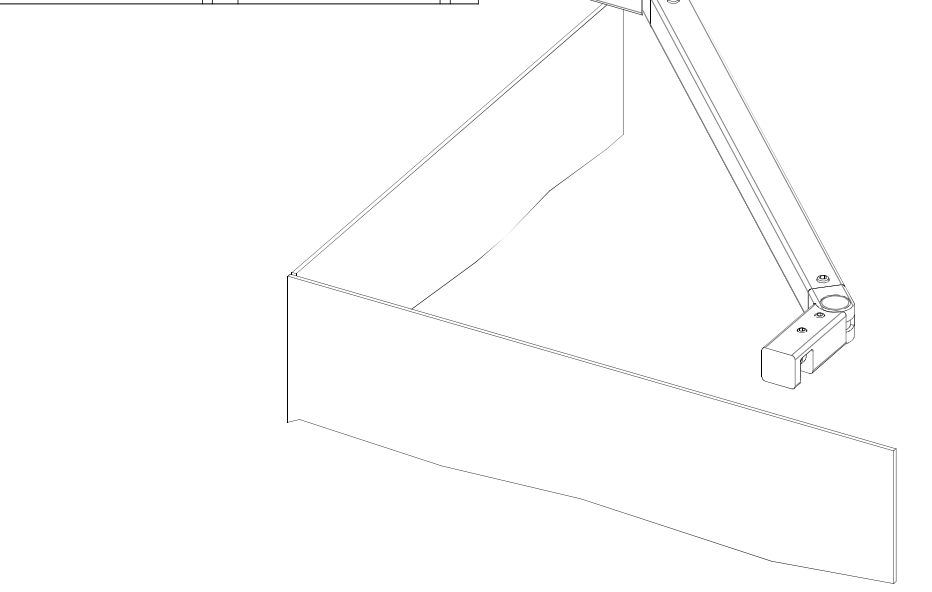
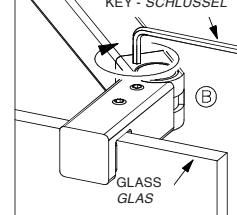

THE BAR'S LENGTH CAN BE CUSTOMIZED
DIE LÄNGE DER STANGE KANN INDIVIDUELLE ANGEPAST WERDEN

A- UNSCREW THE DOWEL AND REMOVE THE ENDING PART
DIE SCHRAUBE AUFSCHRAUBEN UND DAS ENDETEIL ENTFERNEN

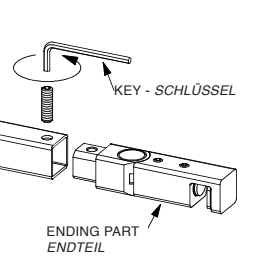

B- CUT THE TUBULAR AT THE DESIRED LENGTH
DAS ROHR AUF DIE GEWÜNSCHTE LÄNGE KÜRZEN

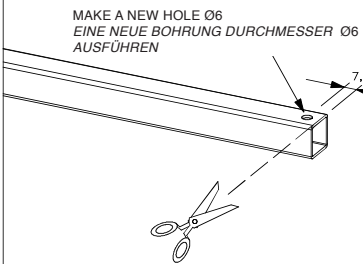

C- MOUNT THE ENDING PART AGAIN BY SCREWING THE DOWEL
DAS ENDETEIL DURCH ANZIEHEN DER SCHRAUBE WIEDER MONTIEREN

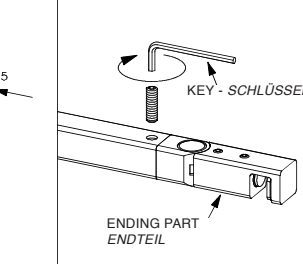

5F27 FERMAVETRO QUADRO BARRA REFUERZO - SECCIÓN CUADRADA

1- CLAMP THE GLASS BY SCREWING THE DOWEL
DAS GLAS WIRD DURCH ANZIEHEN DER SCHRAUBE

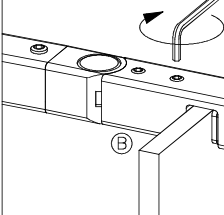

2- BLOCK THE POSITION BY SCREWING THE DOWEL - BLOCKIEREN DIESER POSITION ERFOLGT DURCH ANZIEHEN

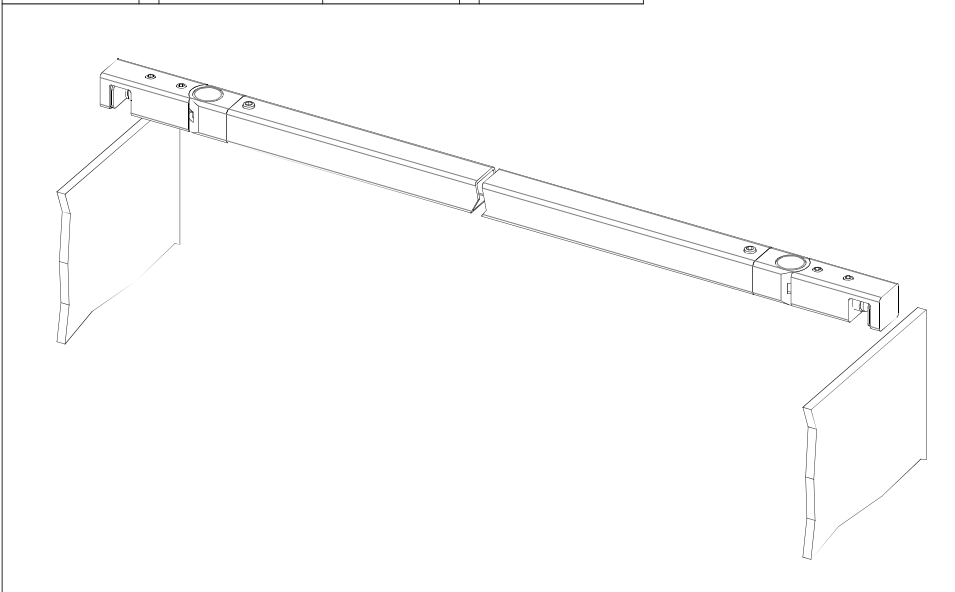
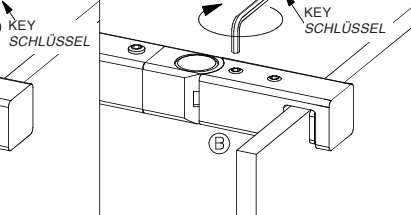

THE BAR'S LENGTH CAN BE CUSTOMIZED
DIE LÄNGE DER STANGE KANN INDIVIDUELLE ANGEPAST WERDEN

A- UNSCREW THE DOWEL AND REMOVE THE ENDING PART
DIE SCHRAUBE AUFSCHRAUBEN UND DAS ENDETEIL ENTFERNEN

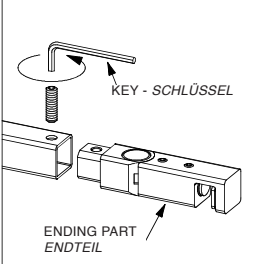

B- CUT THE TUBULAR AT THE DESIRED LENGTH
DAS ROHR AUF DIE GEWÜNSCHTE LÄNGE KÜRZEN

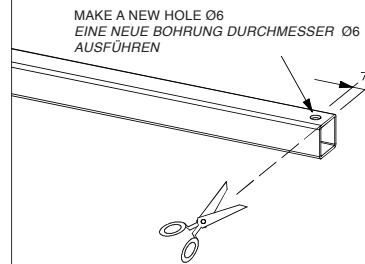

C- MOUNT THE ENDING PART AGAIN BY SCREWING THE DOWEL
DAS ENDETEIL DURCH ANZIEHEN DER SCHRAUBE WIEDER MONTIEREN

