

serie BILOBA

CERNIERE OLEODINAMICHE CHIUDIPIORTA

Bisagras hidráulicas cierrapuerta
Oildynamic door closers hinges
Hydraulisches Türschließer Bänder



We Build the Invisible

colcomgroup.it
follow us on [f](#) [▶](#) [t](#) [in](#)

webuildtheinvisible.com
follow us on [f](#) [@](#) [▶](#) [in](#)



ITALIA DEGLI INNOVATORI
Agenzia per la Diffusione delle Tecnologie per l'Innovazione
Presidenza del Consiglio dei Ministri

Le cerniere oleodinamiche hanno ottenuto dal TÜV la certificazione EN 1154 che le equipara a tutti gli effetti a dei chiudiporta pur avendo un rendimento ben superiore (oltre il 90% per le cerniere contro il 50-60% dei tradizionali chiudiporta).

The hydraulic hinges got TÜV certification EN 1154 that levels them to all intents and purposes to floor springs, even if they have a higher performance (over 90% for the hinges vs 50-60% of traditional floor springs).



We Build the Invisible

Cerniere Chiudiporta - Pensiero Oleodinamico

La ricca produzione di Colcom si distingue per il sistema oleodinamico applicato a cerniere chiudiporta. Di nuova concezione ideato e realizzato dall'ufficio Ricerca & Sviluppo dell'azienda e coperto da brevetto internazionale. Cerniere oleodinamiche che consentono la chiusura automatica, costante e controllata delle porte con velocità regolabile e rappresentano sintesi ed evoluzione delle tradizionali cerniere automatiche e dei chiudiporta tradizionali. Le nostre cerniere chiudiporta hanno ottenuto dal TÜV, la certificazione EN 1154 che le equipara a tutti gli effetti a dei chiudiporta.

Door closers Hinges - Hydraulic thought

The rich production of Colcom is characterized by the hydraulic system applied to door closer hinges, a new concept designed and realized by the R&D department and covered by international patent. Hydraulic hinges that ensure a constant and controlled door closing with adjustable speed and represent the evolution of the traditional automatic hinges and door closers. Our door closer hinges have been certified by TÜV, EN 1154, which equalizes them in all aspects to the traditional door closers.



Bisagras Cierrapuerta - Conocimiento hidráulico

La gran producción de Colcom se distingue por el sistema hidráulico empleado en las bisagras cierra puerta. El nuevo concepto diseñado y implementado por la Oficina de Investigación y Desarrollo y que está cubierto con una patente internacional. Bisagras hidráulicas que permiten el cierre constante y controlado de la puerta con velocidad regulable y que representan la síntesis y evolución de las bisagras automáticas y el freno de suelo tradicional. Nuestras bisagras cierra puerta - están patentada por TUV.

Türschließer Bänder - Das Hydraulik-Konzept

Die vielfältige Produktion von Colcom hebt sich besonders durch seine hydraulischen Lösungen für selbstschließende Türbänder ab. Dieses neuartige Konzept wurde von der betriebseigenen R&D Abteilung entwickelt und international patentiert. Hydraulikbänder mit regulierbarer Schließgeschwindigkeit, die einen sanften und kontrollierten Schließablauf der Tür ermöglichen. Diese Bänder stellen eine Synthese eines Automatikbandes und eines hydraulischen Türschliebers dar. Unsere Beschläge sind durch den TÜV nach EN 1154 zertifiziert und sind somit in jeder Hinsicht gleichgestellt mit den traditionellen Türschließern.



Biloba



cod.8010

Nasce per porte interne e consente la chiusura automatica dell'anta. La velocità del movimento è regolabile e di massima sicurezza in quanto non oppone resistenza. Adatta anche per porte in battuta.

Nació para puertas interiores y permite el cierre automático. La velocidad del movimiento, es ajustable y es segura ya que no resiste. Puede ser tambien para puerta con tope.

It is born for inner doors and allows the automatic closing. The moving speed is adjustable and very safety, because the door does not offer resistance. Also suitable for doors with stop.

Entwickelt wurde für Innentüren, und macht die automatische Schließung möglich. Die Geschwindigkeit der Bewegung ist einstellbar und von maximaler Sicherheit, da die Tür keinen Widerstand leistet, wenn sie unbeabsichtigt fest gestoßen wird. Auch für Anschlagtüren geeignet.



cod.8011

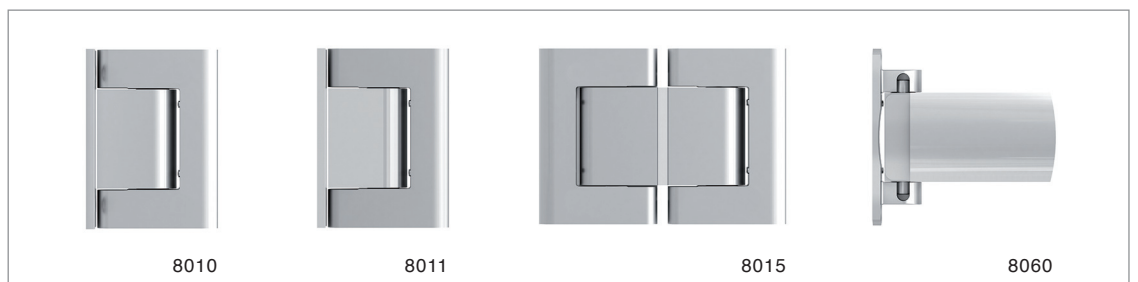

8010

8011

8015

8060



Biloba



cod.8015

Biloba 8015 è la cerniera vetro-vetro con regolazione della velocità di chiusura dell'anta. Stop a 0° +90° -90°. La velocità del movimento è regolabile e di massima sicurezza in quanto non oppone resistenza. Collaudata per oltre un milione di cicli e coperta da brevetto internazionale. Adatta anche per porte in battuta.

Biloba 8015 es la bisagra cierra puerta hidráulica (vidrio-vidrio), con ajuste de velocidad de cierre de la puerta. Tope 0° +90° -90°. La velocidad del movimiento es ajustable y es segura ya que no resiste. Probadas por más de un millón de ciclos y cubierta por una patente internacional. Puede ser tambien para puertas con tope.

Biloba 8015 is the glass-glass hinge with adjustment of the door closing speed. Stop at 0° +90° -90°. The moving speed is adjustable and very safe, because the door does not exert resistance. It has been tested for more than one million cycles and is covered by international patent. Also suitable for doors with stop.

Biloba 8015 ist die Variante Glas-Glas mit Einstellung der Türgeschwindigkeit. Stopp bei 0° +90° -90°. Die Geschwindigkeit der Bewegung ist einstellbar und von maximaler Sicherheit, da die Tür keinen Widerstand leistet. Getestet über eine Millionen Öffnungs- und Schließzyklen und international patent geschützt.



Biloba



cod. 8060

Biloba 8060 è la cerniera con regolazione della velocità di chiusura dell'anta ideata per porte in battuta. Stop a 0° +90°. La velocità del movimento è regolabile ed è di massima sicurezza in quanto non oppone resistenza. Collaudata per oltre un milione di cicli e coperta da brevetto internazionale.

Biloba 8060 es para puertas internas con tope en el perímetro. Es ideal para lugares que requieren sellado. Tope 0° +90° -90°. La velocidad del movimiento es ajustable y es segura ya que no resiste. Probadas por más de un millón de ciclos y cubierta por una patente internacional.

Biloba 8060 is a hinge with adjustment of the closing speed of the doors with stop. Stop at 0° +90°. The speed is adjustable and very safe as the door does not exert any resistance. It has been tested for more than one million cycles and is covered by international patent.

Biloba 8060 ist ein Band mit Feststellung der Schließgeschwindigkeit für Anschlagtüren. Stopp bei 0° +90°. Die Schließgeschwindigkeit ist einstellbar und von maximaler Sicherheit, da die Tür keinen Widerstand leistet. Getestet über eine Millionen Öffnungs- und Schließzyklen und international patentgeschützt.



Biloba JC



cod.8010JC

Le Biloba JC oltre alle consuete caratteristiche oleodinamiche hanno la **regolazione del punto 0** e un corpo interno completamente anodizzato. Lo speciale trattamento di ossidazione con alti spessori (20 micron), e il rivestimento dell'intera superficie con copertine in acciaio inox AISI 316, hanno consentito strepitose resistenze alla corrosione, oltrepassando la soglia della 500 ore in nebbia salina/acetica (secondo le norme UNI ISO 9227 AASS Acetic Acid Salt Spray), senza mostrare alcun segno di imperfezione.

Las bisagras "Biloba JC", además de las habituales características hidráulicas tienen **ajuste del punto 0°**, un cuerpo interior totalmente

anodizado. El especial tratamiento de oxidación con alto espesor (20 micras) y el revestimiento de la tapas en acero inoxidable 316 AISI, permitió una resistencia notable a la corrosión, pasando el umbral de 500 horas * niebla salina acética (según UNI ISO 9227 AASS Acetic Acid Salt Spray), sin mostrar ningún signo de imperfecciones.

The Bilobas JC, in addition to the usual hydraulic features, have a **zero point adjustability** and a completely anodized inner body. The special deep oxidation (20 micron) and the coating of the entire surface with covers made of stainless steel AISI 316 are very highly resistant to corrosion, more than 500 hours in acetic acid salt spray (according to



cod.8010JC

UNI ISO 9227 AASS Acetic Acid Salt Spray) without showing any sign of imperfection.

Wir haben nun Biloba JC. Neben den gewöhnlichen, hydraulischen Merkmalen haben Sie einen inneren **0°-Punkt-Regulierung**, komplett eloxierten Körper. Die Sonderoxydationsbehandlung (20 Mikron) und die Verkleidung mit Abdeckungen aus Edelstahl AISI 316 erhöhen die Korrosionsfestigkeit mit erfolgreichen Resultaten (nach UNI ISO 9227 AASS Acetic Acid Salt Spray) ohne Mangel.

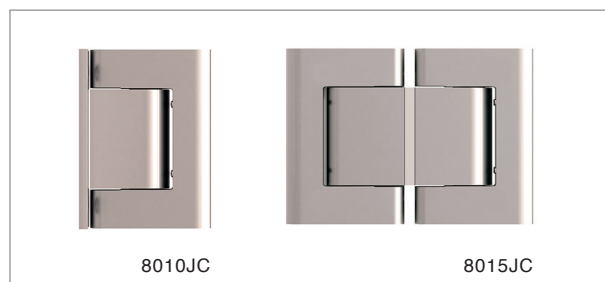



Biloba BT

cod.8010BT

Cerniere oleodinamiche nate per l'applicazione in ambienti umidi come box doccia, saune e bagni turchi. Dotate di tutte le caratteristiche che contraddistinguono l'intera gamma Biloba, le nuove cerniere della serie BT montano un perno in acciaio INOX AISI 420 e guarnizioni OR in Viton. Supportano pertanto temperature fino a 100°. Finitura testata, garantita e quindi consigliata è la "22" (ossidazione profonda 20 micron).

Bisagras hidráulicas por el uso en ambientes húmedos tales como ducha, sauna y baño turco. Tienen todas las características que distinguen a la gama de "Biloba"; la nueva serie BT monta eje de acero inoxidable AISI 420 y OR en Vitón. Por lo tanto, soportan temperatura hasta 100°C. Acabado garantizado; se recomienda el "22" (oxidación profunda 20 micrones).

Hydraulic hinges born for application in wet areas such as showers, saunas and steam baths. Equipped with features characterizing the full Biloba range, the new BT series hinges mount the pin in INOX AISI 420 stainless steel and Viton OR-rings. Therefore they resist to temperatures up to 100°C. The tested, guaranteed and therefore recommended finishing is „22“ (deep oxidation 20 microns).

Hydraulische Scharniere für den Einsatz in Nassbereichen wie Duschen, Saunen und Dampfbädern. Ausgestattet mit allen Charakterisierungen der gesamten Biloba Palette, die neuen Scharniere der BT Serie montieren den Stift aus Edelstahl AISI 420 und Viton-OR-Dichtungringe. Deshalb vertragen sie Temperaturen bis zu 100°C. Die getestete, garantierte und daher empfohlene Feinbearbeitung ist „22“ (tiefe Oxidation 20 Mikron).



cod.8060BT



8010BT



8011BT



8015BT

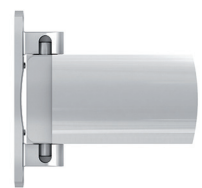

8060BT



Kit per porta SAUNA

Il kit per l'ambiente sauna è composto da 2 cerniere Biloba 8060BT in abbinamento al pomolo in legno.

El kit de sauna es con dos bisagras "Biloba" 8060BT - en combinación al pomolo de madera.

The sauna set comprises of: 2 Biloba hinges 8060BT and 1 pair of wooden knob.

Der Bausatz für Sauna besteht aus 2 Hydraulikbänder Biloba 8060BT und 1 Holzknopfpaar.

cod.KSN8060

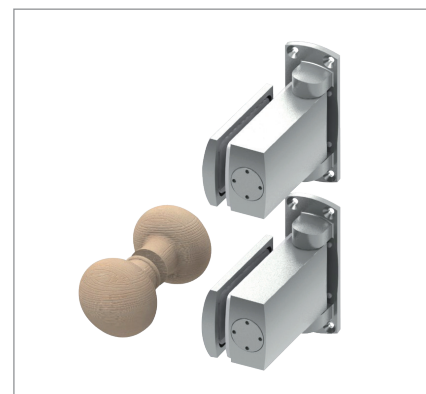



Kit per porta BAGNO TURCO

Il kit è composto da 2 cerniere Biloba 8061BT e dai profili Espro, entrambi da 3,2 metri, che consentono di contenere l'uscita del vapore.

El kit es con dos bisagras "Biloba" 8061BT y perfiles "Espro" de 3,2 metros, que permiten contener eficazmente la salida de vapor.

The steam baths set comprises of 2 Biloba hinges 8061BT and 2 Espro profiles. Espro profiles are both in lengths of 3,2 meters and avoid the steam runoff.

Der Bausatz für Dampfbad besteht aus 2 Hydraulikbänder Biloba 8061BT sowie Espro Profile in jeweiliger Länge von 3,2 Meter, um die Glastür vom Dampfaustritt weitestgehend zu schützen.

cod.KBT8061



Biloba

Porte Interne ed esterne - Puertas Internas y Externas - Inner and Outer Doors - Innen-und Außentüren



8010

Stop a 0° +90° -90°. Adatta anche per porte in battuta.
 Freno a 0°, + 90°, -90°. Tambien adecuada por puertas con tope.
 Stop at 0° +90° -90°. Also suitable for doors with stop.
 Feststellung bei 0° +90° -90°. Auch für Anschlagtüren geeignet.

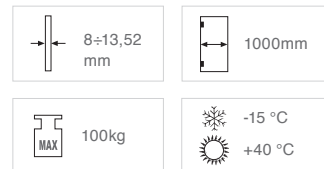

8011

Con aletta spostata. Stop a 0° +90° -90°. Adatta anche per porte in battuta.
 Con aleta desplazada. Freno a 0°, + 90°, -90°. Tambien adecuada por puertas con tope.
 With offset fixing wing. Stop at 0° +90° -90°. Also suitable for doors with stop.
 Einseitige Anschraubplatte. Feststellung bei 0° +90° -90°. Auch für Anschlagtüren geeignet.

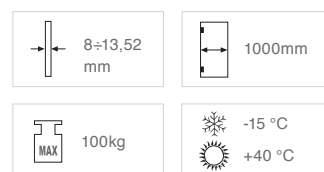

8015

Vetro-vetro. Stop a 0° +90° -90°. Adatta anche per porte in battuta.
 Vidrio – vidrio. Freno a 0°, + 90°, -90°. Tambien adecuada por puertas con tope.
 Glass to glass. Stop at 0° +90° -90°. Also suitable for doors with stop.
 Glas-Glas. Feststellung bei 0° +90° -90°. Auch für Anschlagtüren geeignet.

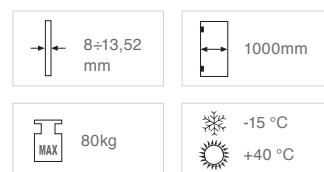

8060

Per porte in battuta. Ideale per chiusure ermetiche. Stop a +90°.
 Por puerta con tope. Lo perfecto por cerradura hermética. Freno a + 90°.
 For doors with stop. Ideal for hermetic closing. Stop at +90°.
 Für Anschlagtüren geeignet. Ideal für hermetische Schließung. Feststellung bei +90°.

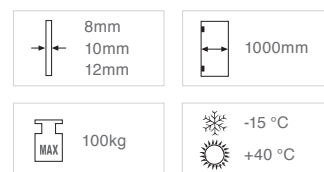

8010JC

Non dotata di freno antivento - Sin freno anti viento
 Anti-wind brake - Keine Bremseventile mit Windschutzfunktion

Stop a 0° +90° -90°. Adatta anche per porte in battuta.
 Freno a 0°, + 90°, -90°. Tambien adecuada por puertas con tope.
 Stop at 0° +90° -90°. Also suitable for doors with stop.
 Feststellung bei 0° +90° -90°. Auch für Anschlagtüren geeignet.

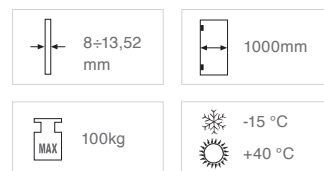

8015JC

Non dotata di freno antivento - Sin freno anti viento
 Anti-wind brake - Keine Bremseventile mit Windschutzfunktion

Vetro-vetro. Stop a 0° +90° -90°. Adatta anche per porte in battuta.
 Vidrio – vidrio. Freno a 0°, + 90°, -90°. Tambien adecuada por puertas con tope.
 Glass to glass. Stop at 0° +90° -90°. Also suitable for doors with stop.
 Glas-Glas. Feststellung bei 0° +90° -90°. Auch für Anschlagtüren geeignet.

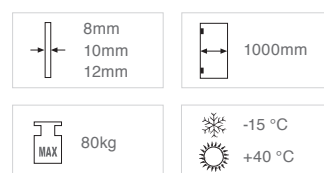

Biloba BT

Doccia e Bagni Turchi - Ducha y Baño Turco - Showers and Steam Baths - Duschen und Dampfbäder



8010BT

Cerniera specifica per applicazioni in ambienti umidi con alte temperature come saune e bagni turchi. Stop a 0° +90° -90°.

Bisagra nacida por ambientes húmedos y aplicaciones con altas temperaturas - como sauna y baño turco. Freno a 0°, + 90°, -90°.

Hydraulic hinge conceived for applications in damp environments and also high temperature like steam rooms and Turkish baths. Stop at 0° +90° -90°.

Hydraulikband konzipiert für Anwendungen in Feuchträumen Milieus und mit hohen Temperaturen, wie Saunas und Dampfbäder. Feststellung bei 0° +90° -90°.

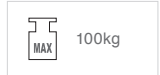
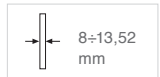

8011BT

Cerniera specifica per applicazioni in ambienti umidi con alte temperature come saune e bagni turchi. Con aletta spostata. Stop a 0° +90° -90°.

Bisagra nacida por ambientes húmedos y aplicaciones con altas temperaturas - como sauna y baño turco. Con aleta desplazada. Freno a 0°, + 90°, -90°.

Hydraulic hinge conceived for applications in damp environments and also high temperature like steam rooms and Turkish baths. With offset fixing wing. Stop at 0° +90° -90°.

Hydraulikband konzipiert für Anwendungen in Feuchträumen Milieus und mit hohen Temperaturen, wie Saunas und Dampfbäder. Einseitige Anschraubplatte. Feststellung bei 0° +90° -90°.

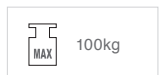
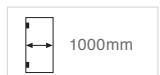
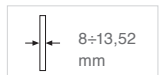

8015BT

Cerniera specifica per applicazioni in ambienti umidi con alte temperature come saune e bagni turchi. Vetro-vetro. Stop a 0° +90° -90°.

Bisagra nacida por ambientes húmedos y aplicaciones con altas temperaturas - como sauna y baño turco. Vidrio - vidrio. Freno a 0°, + 90°, -90°.

Hydraulic hinge conceived for applications in damp environments and also high temperature like steam rooms and Turkish baths. Glass to glass. Stop at 0° +90° -90°.

Hydraulikband konzipiert für Anwendungen in Feuchträumen Milieus und mit hohen Temperaturen, wie Saunas und Dampfbäder. Glas-Glas. Feststellung bei 0° +90° -90°.

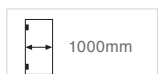

8060BT

Cerniera specifica per applicazioni in ambienti umidi con alte temperature come saune e bagni turchi. Ideale per chiusure ermetiche. Stop a +90°.

Bisagra nacida por ambientes húmedos y aplicaciones con altas temperaturas - como sauna y baño turco. Por puerta con tope. Lo perfecto por cerradura hermética. Freno a +90°.

Hydraulic hinge conceived for applications in damp environments and also high temperature like steam rooms and Turkish baths. For door with stop. Ideal for hermetic closing. Stop at +90°.

Hydraulikband konzipiert für Anwendungen in Feuchträumen Milieus und mit hohen Temperaturen, wie Saunas und Türkische Dampfbäder. Für Anschlagtüren geeignet. Ideal für hermetische Schließung. Feststellung bei +90°.

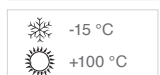
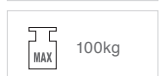

Kit BT

Doccia e Bagni Turchi - Ducha y Baño Turco - Showers and Steam Baths - Duschen und Dampfbäder

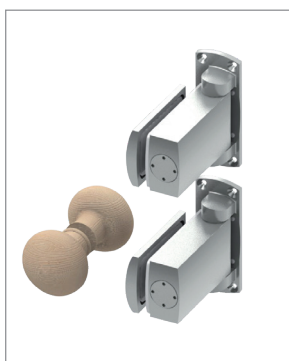

KSN8060

Il kit per l'ambiente sauna è composto da 2 cerniere Biloba 8060BT in abbinamento al pomolo in legno art.5006BT. Freno a + 90°.

El kit de sauna es con dos bisagras "Biloba" 8060BT - en combinación al pomo de madera art.5006BT. Freno a + 90°.

The sauna set comprises of: 2 Biloba hinges 8060BT and 1 pair of wooden knob 5006BT. Stop at +90°.

Bausatz für Sauna bestehend aus 2 Hydraulikbänder Biloba 8060BT mit Feststellung + 90° und 1 Holzknopf 5006BT.

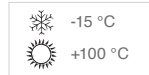

KBT8061

Il kit è composto da 2 cerniere Biloba 8061BT e dai profili Espro, 2 PCC08K + 2 PCC03K entrambi da 3,2 metri, che consentono di contenere l'uscita del vapore. Stop a 90°.

El kit es con dos bisagras "Biloba" 8061BT y perfiles "Espro" - 2 PCC08K + 2 PCC03K de 3,2 metros, que permiten contener eficazmente la salida de vapor. Freno a 90°.

The steam baths set comprises of 2 Biloba hinges 8061BT, 2 Espro profiles PCC08K and 2 Espro profiles PCC03K. Espro profiles are both in lengths of 3,2 meters and avoid the steam runoff. Stop at 90°.

Bausatz für Dampfbad bestehend aus 2 Hydraulikbänder Biloba 8061BT mit Feststellung + 90° und Espro Profile in jeweiliger Länge 3,2 Meter bestehend aus 2 Stück PCC08K und 2 Stück PCC03K.

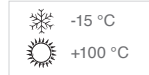
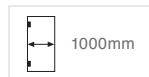

Copyright © Colcom Group Spa

L'azienda si riserva la facoltà di apportare senza preavviso modifiche dovute all'evoluzione tecnica dei prodotti. Si consiglia di consultare l'ufficio tecnico per aggiornamenti e maggiori informazioni sulle schede tecniche specifiche.

The company reserves the right to introduce changes without notice on the basis of the technical development of the products. We suggest to take advice of the technical department for updating and further information on technical data sheets.



We Build the Invisible

Colcom Group S.p.A.

Tel. (+39)0302532008 - (+39)0302530289

Fax. (+39)0302534707

colcomgroup.it

Via degli Artigiani, n° 56 int.1 - 25075 Nave (Brescia) - Italy

We Build the Invisible

