

FLUIDO+ 150

MAX 150 Kg - 330 lbs

Porte - Doors

PORTE IN LEGNO / WOODEN DOORS Soluzioni e Profili - Solutions and Profiles

SCORREVOLE A SOFFITTO - PORTA IN LEGNO

Sliding on Ceiling - Wooden Door

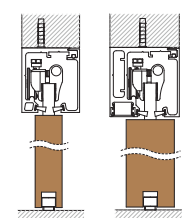

▶ < 40mm ▶ > 40mm

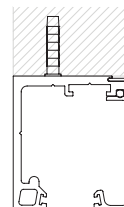
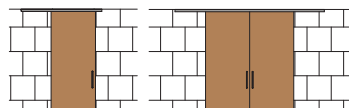

67 x 70 mm

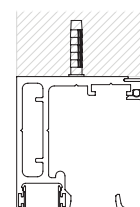

72 x 72 mm

SCORREVOLE A PARETE - PORTA IN LEGNO

Sliding on Wall - Wooden Door

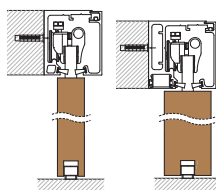

▶ < 40mm ▶ > 40mm

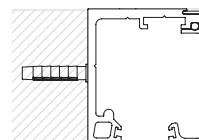
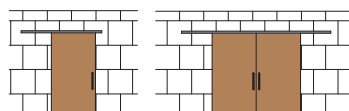

67 x 70 mm

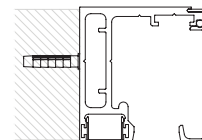

72 x 72 mm

SCORREVOLE A SOFFITTO - PORTA IN LEGNO CON FISSO

Sliding on Ceiling - Wooden Door with Sidelight

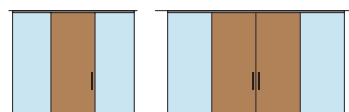
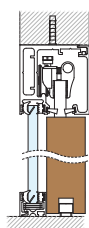



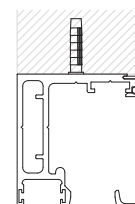













72 x 72 mm



FLUIDO+ 150

Dettagli Tecnici - Technical details

	PORTATA Weight	150kg per porta / for door 330lbs		
	SPESORE VETRO Glass thickness	10 ÷ 14 mm 3/8" to 9/16"		
	SPESORE PORTA IN LEGNO Wooden door thickness	28 ÷ 50 mm 1 1/8" to 1 15/16"		
	REGOLAZIONE IN ALTEZZA Height adjustment	± 3 mm 1/8"		
	DISTANZA A PARETE Wall distance	22 mm 7/8"		
	DISTANZA TRA ANTA E VETRO FISSO Distance between door and sidelight	15.4 ÷ 17.4 mm 5/8" to 11/16"		
	INSTALLAZIONE A VETRO Glass installation	✓		
	INSTALLAZIONE A FALSO SOFFITTO False ceiling installation	✓		
	INSTALLAZIONE TRA PARETI Installation between walls	✓		
	SOFTCLOSE Soft close	Doppio / Double		
	DIMENSIONI MINIME (doppio Softclose) Minimum dimensions (double soft close)	1014 mm 39 3/4"		
	ANTISHOCK Antishock	Doppio / Double		
	DIMENSIONI MINIME (doppio antishock) Minimum dimensions (double antishock)	800 mm 31 1/2"		
	RETAINER MECCANICO Mechanical retainer	Doppio / Double		
	DIMENSIONI MINIME (doppio Retainer) Minimum dimensions (double Retainer)	800 mm 31 1/2"		
	FINITURE Finishes	02 Ossidato naturale Natural oxidized	05 Ossidato nero Black oxidized	13 PVD simil inox similar PVD stainless steel



**CERTIFICAZIONE DURABILITÀ
CICLI CORROSIONE**
Durability certification
Corrosion cycles

DURABILITÀ (100.000 Cicli)
Durability (100.000 Cycles)

PESO DELLA PORTA (da 101 a 330 kg)
Door mass (from 101 up to 330 kg)

SICUREZZA (Grado 1 per tutti gli scorrevoli)
Safety (All sliding must be grade 1)

RESISTENZA ALLA CORROSIONE (Alta resistenza)
Corrosion resistance (High resistance)

CATEGORIA DELLA PORTA (Porta scorrevole)
Category of door (Sliding door)

FRIZIONE INIZIALE VALORE MASSIMO CONSENTITO (4% della massa)
Initial friction maximum permitted value (4% of the mass)

according to
EN1527

– 6 3 – 1 3 – 1 3

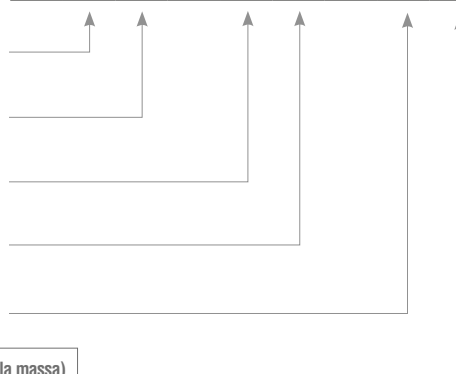

FLUIDO+ 150 A SOFFITTO - ON CEILING

MAX 150 Kg - 330 lbs

Porte - Doors

< 40 mm PORTE IN LEGNO
WOODEN DOORS

- Profili per scorrevole in legno - fissaggio a soffitto.
- Perfil para sistema corredero - puertas de madera - fijación a techo.
- Profiles for sliders - wooden doors - fixed on ceiling.
- Schiebeseystem Fluido - Holztüren - Befestigung an der Decke.
- Profils pour coulissants - Portes en bois - fixation au plafond.

B150EK00

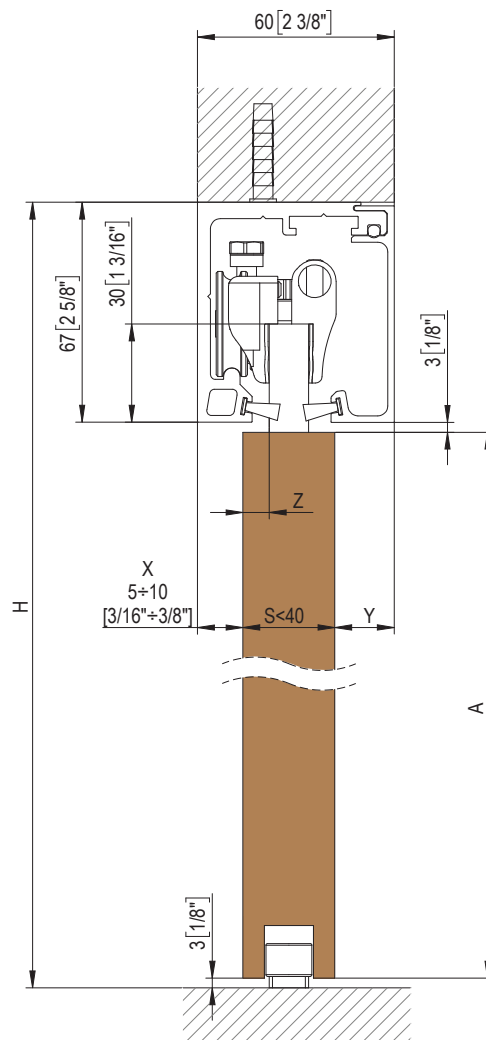
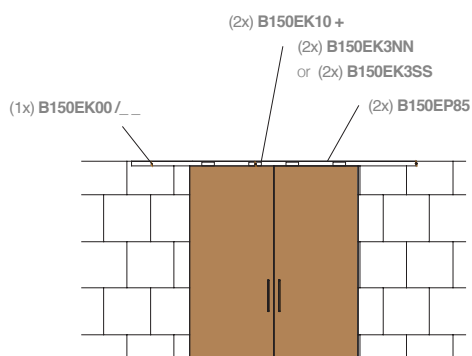
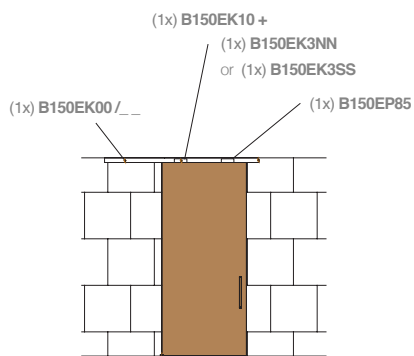
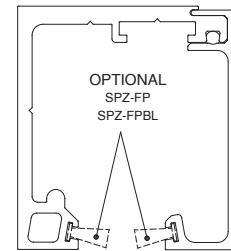

$$\begin{aligned}
 A &= H - 73 \\
 [A &= H - 2 \text{ 7/8"}] \\
 Y &= 60 - X - S \\
 [Y &= [2 \text{ 3/8"} - X - S] \\
 Z &= 22 - X \\
 [Z &= 7/8" - X]
 \end{aligned}$$

FLUIDO+ 150 A PARETE - ON WALL

MAX 150 Kg - 330 lbs

Porte - Doors

< 40 mm PORTE IN LEGNO
WOODEN DOORS

- Profili per scorrevole in legno
- fissaggio a parete.
- Perfil para sistema corredero - puertas de madera
- fijación a pared.
- Profiles for sliders - wooden doors
- fixed on wall.
- Schiebeseystem Fluido - Holztüren
- Befestigung an der Wand.
- Profils pour coulissants - Portes en bois
- fixation au mur.

B150EK00

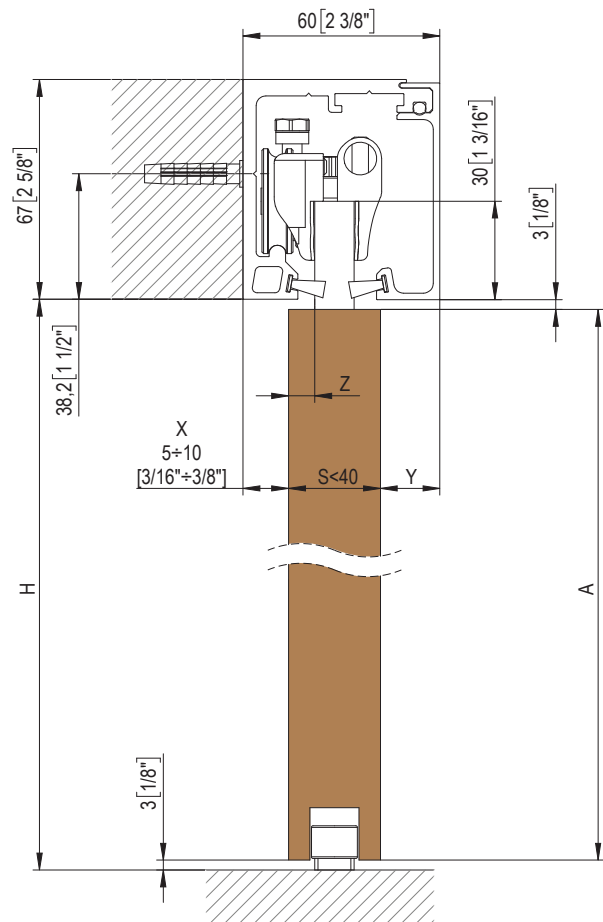
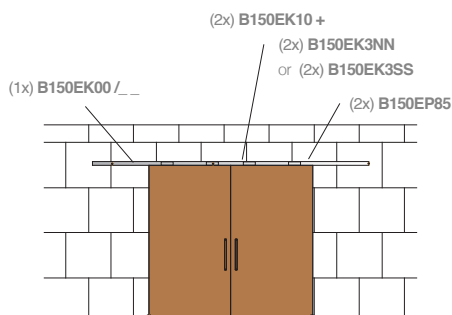
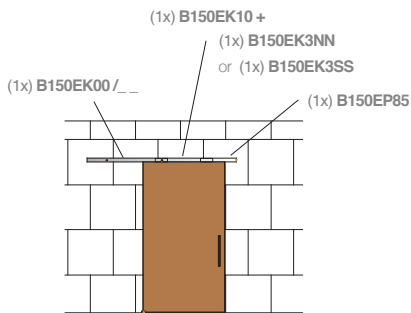
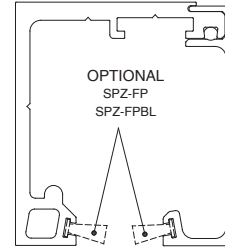

$$\begin{aligned}
 A &= H - 6 \\
 [A &= H - 1/4"] \\
 Y &= 60 - X - S \\
 [Y &= [2 3/8" - X - S] \\
 Z &= 22 - X \\
 [Z &= 7/8" - X]
 \end{aligned}$$

SCORREVOLI
SLIDING

FLUIDO+ 150 A SOFFITTO • ON CEILING

MAX 150 Kg - 330 lbs

Porte - Doors

> 40 mm PORTE IN LEGNO
WOODEN DOORS

- Profili per scorrevole in legno
- fissaggio a soffitto.
- Perfil para sistema corredero - puertas de madera
- fijación a techo.
- Profiles for sliders - wooden doors
- fixed on ceiling.
- Schiebeseystem Fluido - Holztüren
- Befestigung an der Decke.
- Profils pour coulissants - Portes en bois
- fixation au plafond.

B150EK01

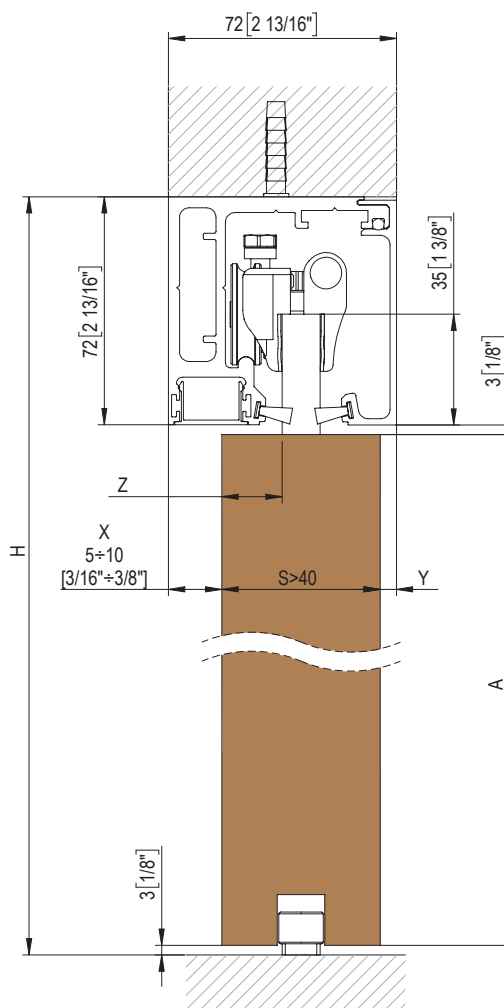
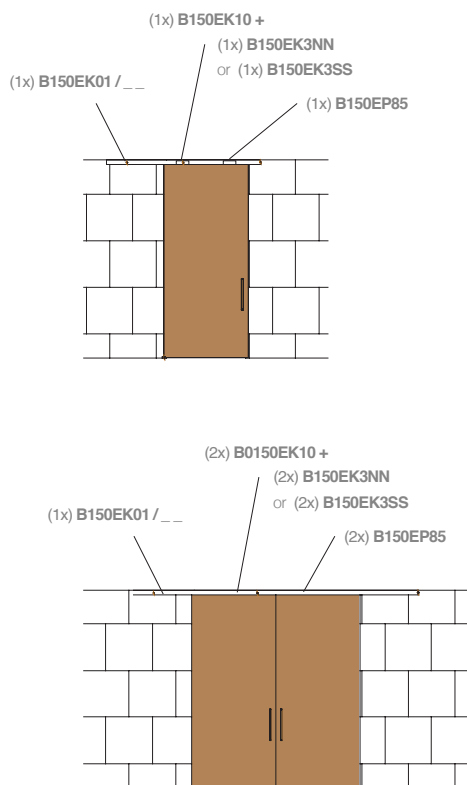
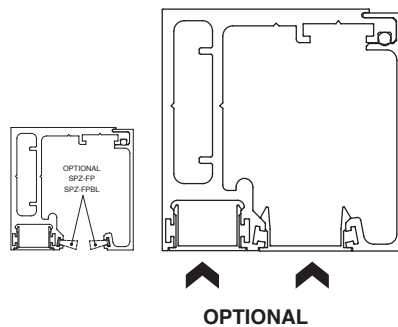

$$\begin{aligned}
 A &= H - 78 \\
 [A &= H - 3 \frac{1}{16}"] \\
 Y &= 72 - X - S \\
 [Y &= [2 \frac{13}{16} - X - S] \\
 Z &= 36 - X
 \end{aligned}$$

FLUIDO+ 150 A PARETE • ON WALL

MAX 150 Kg - 330 lbs

Porte - Doors

> 40 mm PORTE IN LEGNO
WOODEN DOORS

- Profili per scorrevole in legno
- fissaggio a parete.
- Perfil para sistema corredero - puertas de madera
- fijación a pared.
- Profiles for sliders - wooden doors
- fixed on wall.
- Schiebeseystem Fluido - Holztüren
- Befestigung an der Wand.
- Profils pour coulissants - Portes en bois
- fixation au mur.

B150EK01

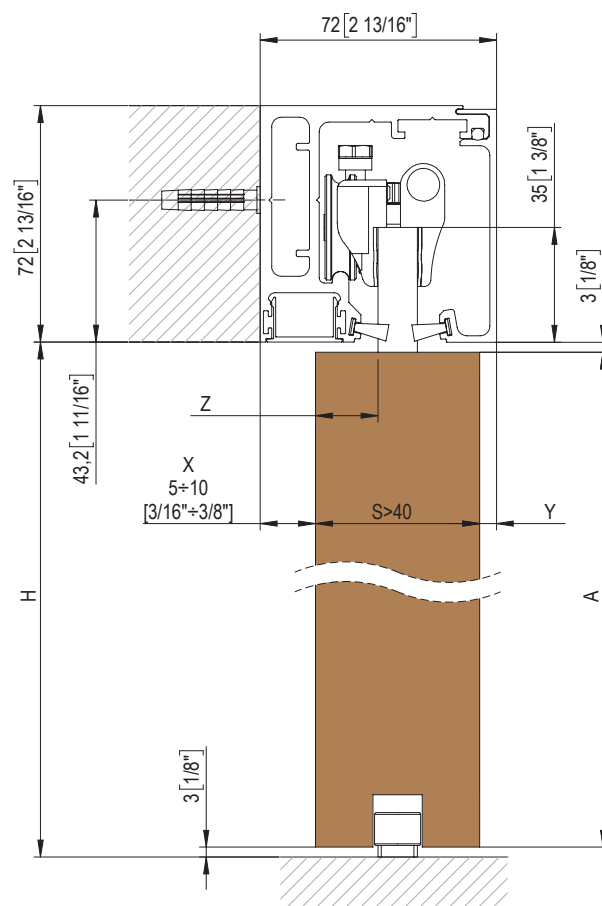
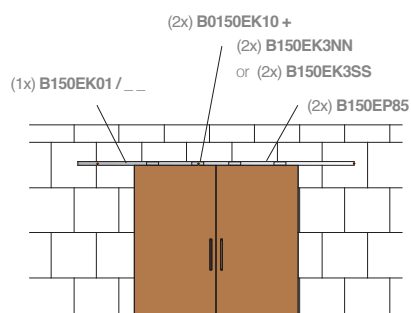
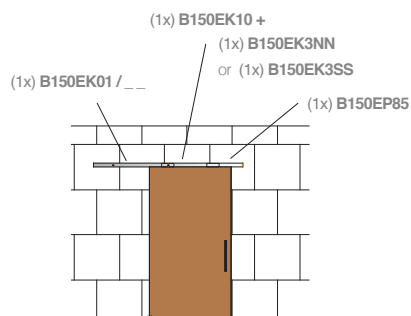
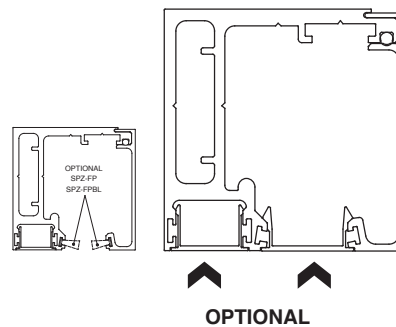

$$\begin{aligned}
 A &= H - 6 \\
 [A &= H - 1/4"] \\
 Y &= 72 - X - S \\
 [Y &= [2\ 13/16" - X - S] \\
 Z &= 36 - X \\
 [Z &= 1\ 7/16" - X]
 \end{aligned}$$

FLUIDO+ 150 A SOFFITTO CON FISSO - ON CEILING WITH SIDELIGHT

MAX 150 Kg - 330 lbs

Porte - Doors

- Profili per scorrevole in legno
- fissaggio a soffitto con vetro fisso.
- Perfil para sistema corredero - puertas de madera
- fijación a techo con vidrio fijo.
- Profiles for sliders - wooden doors
- fixed on ceiling with fixed glass.
- Schiebesystem Fluido - Holztüren
- Befestigung an Decke mit Seitenteilen aus Glas.
- Profils pour coulissant - Portes en bois
- fixation au plafond avec verre fixe.

B150EK01

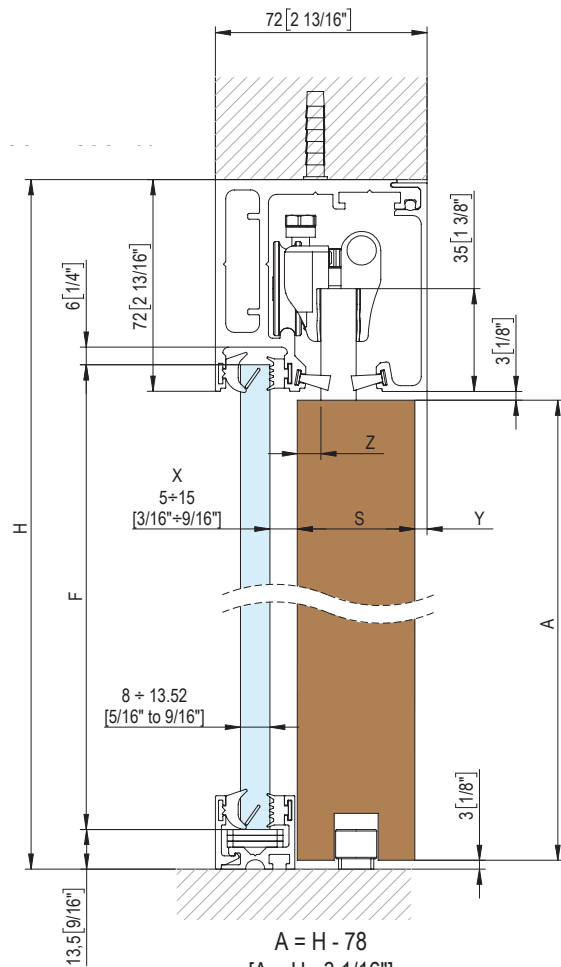
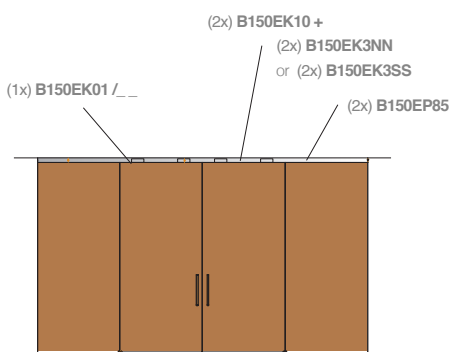
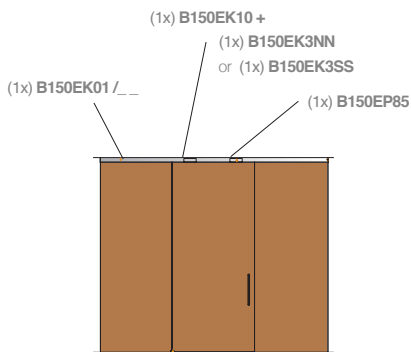
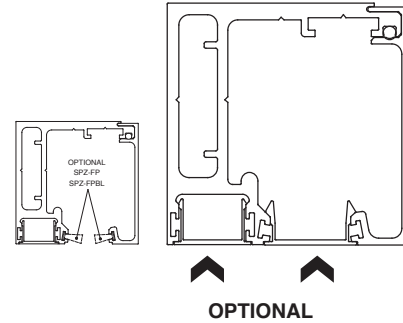

$$\begin{aligned}
 A &= H - 78 \\
 [A &= H - 3 \frac{1}{16}"] \\
 F &= H - 77 \\
 [F &= H - 3 \frac{1}{16}"] \\
 Y &= 72 - X - S \\
 [Y &= [2 \frac{13}{16}"] - X - S] \\
 Z &= 17 - X \\
 [Z &= 11 \frac{1}{16}"] - X]
 \end{aligned}$$

FLUIDO+ 150

PROFILI BINARIO- PROFILES RAIL

150 Kg - 330 lbs

Porte - Doors

B150EK00/2 (2 m)
B150EK00/3 (3 m)
B150EK00/3.2 (3,2 m)
B150EK00/4 (4 m)
B150EK00/6 (6 m)

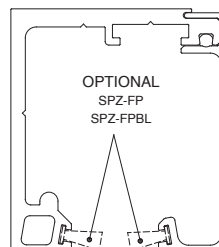

- Profilo binario per scorrevole: soffitto, parete e su vetro fisso.
- Perfil corredero para instalación a techo, pared y pared de vidrio.
- Sliding profile for ceiling, wall and sidelight installation.
- Schiebetürprofil für Decken-, Wand- und Glaswandeinbau.
- Profil de rail coulissant : plafond, mur et verre fixe.

B150EK01/2 (2 m)
B150EK01/3 (3 m)
B150EK01/3.2 (3,2 m)
B150EK01/4 (4 m)
B150EK01/6 (6 m)

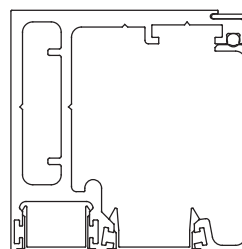
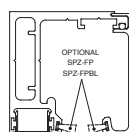

- Profilo binario per scorrevole a soffitto con vetro fisso
- Perfil corredero para instalación a techo con paño fijo.
- Sliding profile for ceiling with sidelight installation.
- Schiebetürprofil für Deckeneinbau mit seitlichen Glas.
- Profil coulissant de plafond avec verre fixe.

B150EP45/2 (2mt)
B150EP45/3 (3mt)
B150EP45/3.2 (3.2mt)
B0150EP45/4 (4mt)
B150EP45/6 (6mt)

OPTIONAL

B150EP46/2 (2mt)
B150EP46/3 (3mt)
B0150EP46/3.2 (3.2mt)
B150EP46/4 (4mt)
B150EP46/6 (6mt)

OPTIONAL

B150EK02/2 (2 m)
B150EK02/3 (3 m)
B150EK02/3.2 (3,2 m)
B150EK02/4 (4 m)
B150EK02/6 (6 m)

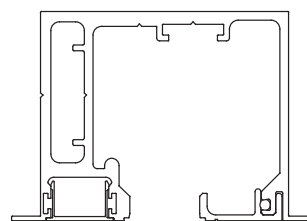

B150EP45/2 (2mt)
B150EP45/3 (3mt)
B150EP45/3.2 (3.2mt)
B0150EP45/4 (4mt)
B150EP45/6 (6mt)

OPTIONAL

- Profilo binario per scorrevole a falso soffitto e a falso soffitto con vetro fisso
- Perfil corredero para instalación a falso techo, con o sin paño fijo.
- Sliding profile for false ceiling installation, both with and without sidelight.
- Schiebetürprofil für Zwischendeckeneinbau, mit oder ohne seitlichen Glas.
- Profil coulissant de faux-plafond avec ou sans verre fixe.

FLUIDO+ 150

KIT PINZE- CLAMPS KIT

MAX 150 Kg - 330 lbs

Porte - Doors

B150EK10



- Kit coppia pinze.
- Kit par de pinzas.
- Kit with pair of clamps.
- Bausatz ein Paar Zangen.
- Kit paire de pinces.

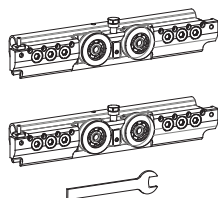

B150EK05



- Kit coppia pinze falso soffitto
- Kit par de pinzas a cielo falso
- Kit with pair of clamps on false ceiling.
- Bausatz ein Paar Zangen an abgehängter Decke.
- Kit paire de pinces faux-plafond.

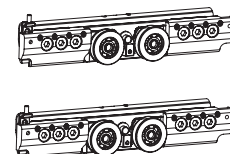

B150EK3NN

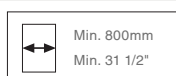

- Kit coppia Retainer. Stop meccanico
- Kit par tope mecánico
- Kit with pair of mechanical stops
- Bausatz ein Paar mechanische Stopper
- Kit paire arrêt mécanique

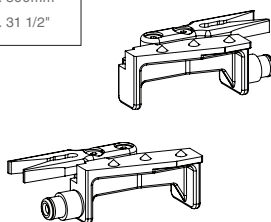

B150EK3AA

- Kit coppia Retainer + Antishock
- Kit par tope mecánico + antichoque
- Kit with pair of mechanical stops and anti-shock feature
- Bausatz ein Paar mechanische Stopper + Antishock
- Kit paire arrêt mécanique + butée antichoc

B150EK3SS

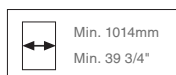

- Kit coppia Soft Close CPCS
- Kit par Soft Close CPCS
- Kit with Soft Close CPCS pair
- Bausatz ein Paar Soft Close CPCS
- Kit paire Soft Close CPCS

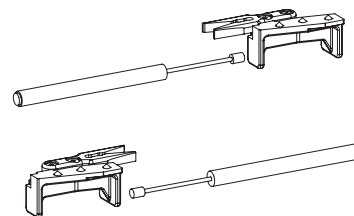
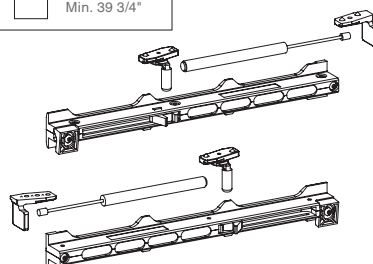

B150EK66

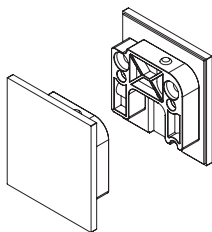

- Coppia di tappi.
- Par de tapones
- Pair of caps
- Paar Kappen
- Paire de bouchons

B150EK67

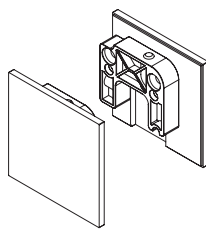

- Coppia di tappi per versione con fisso laterale.
- Par de tapones para versión con cristal fijo lateral
- Pair of caps for model with side fixed glass
- Paar Kappen für Version mit festem Seitenglas
- Paire de bouchons pour version avec vitrage fixe latéral

B150EK68

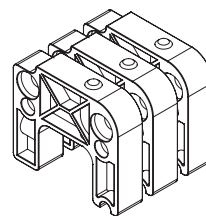

- Kit spessore per Veletta e supporti laterali - Consigliato per binari oltre i 2,5m
- Kit cuña para panel y soportes laterales - Aconsejado para perfiles de largo superior a 2,5 m
- Set spacer for casing and side fittings - Recommended for rails longer than 2,5 m
- Set Distanzstück für Anlauf und Seitenträger - Empfohlen für Profilen über 2,5 m
- Kit épaisseur pour panneau et supports latéraux - Recommandé pour les profils de plus de 2,5 m

FLUIDO+ 150

COMPONENTI- COMPONENTS

MAX 150 Kg - 330 lbs

Porte - Doors

B150EP48

- Tassello di collegamento - per vetro fisso
- Pieza de unión - para cristal fijo
- Connection insert - for fixed glass
- Verbindungsdübel - für festem Glas
- Tasseau d'assemblage - pour vitrage fixe

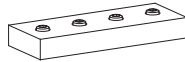

BF50

- Guida a terra.
- Guía de suelo
- Ground slide
- Bodenführung
- Guide au sol

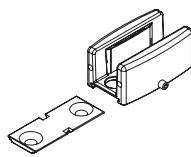
SPZ-FP
SPZ-FPBL

- Guarnizione a spazzola in tessuto
- Guarnición de tela
- Fabric brush seal
- Stoffbürstendichtung
- Joint de brosse en tissu



B150EP85

- Kit accessorio per porte in legno.
- Kit accesorios para puertas de madera.
- Accessory kit for wooden doors.
- Zubehörkit für Holzüren.
- Kit accessoires pour portes en bois.

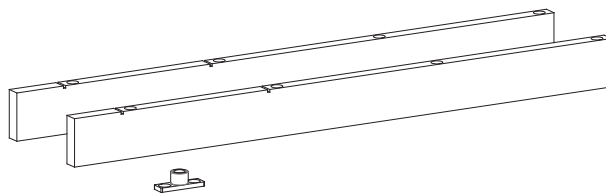

BF70

- Borchia per fissaggio barra a vetro.
- Perno de fijación de la barra al cristal
- Boss for securing glass bar
- Senkschraube zur Befestigung der Stange am Glas
- Clou de fixation de la barre à la vitre

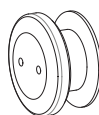

Lunghezza barra

Longitud de la barra
Bar length
Profillänge
Longueur de barre

Quantità borchie

Cantidad tornillos
Quantity of studs
Anzahl der Stifte
Quantité

Lunghezza barra	Quantità borchie
2 mt	5
3 mt	7
3,2 mt	8
4 mt	10
6 mt	15

DETTAGLIO FORATURA FISSAGGIO A VETRO - DETAILS DRILLING FOR GLASS FIXING

DETALLE AGUJERO PARA FIJACIÓN A VIDRIO - DETAIL DES BOHRENS FÜR DIE GLASFIXIERUNG - PLAN DE PERÇAGE POUR FIXATION SUR VERRE

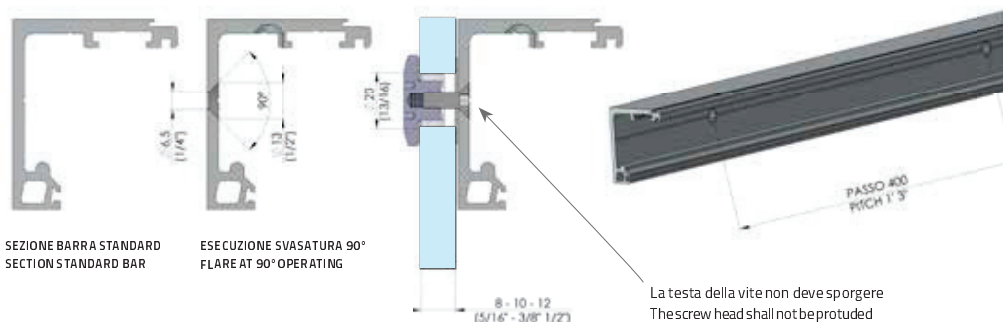

B150EP27 serie FLUIDO+



- Perno per porte battenti da applicare ad estrusi Fluido+.
- Pernio para puertas batientes, por aplicar a perfiles Fluido+.
- Spindle for swing doors, to be applied to Fluido+ profiles.
- Drehpunkt für Pendeltüren für Fluido+ Profilen.
- Pivot pour portes battantes à appliquer sur profils Fluido+.

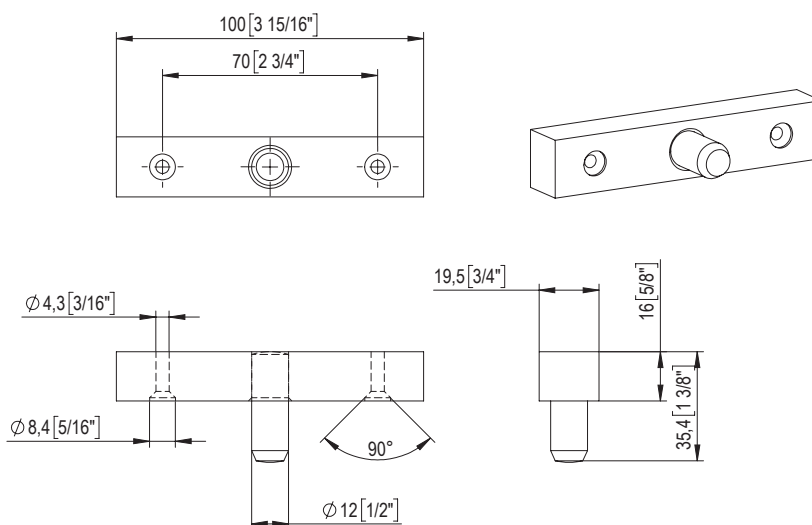

ESEMPIO APPLICAZIONE CON CERNIERA UNICA 101E10 - 100E20

