

815E 10N Bilobina oildynamic hinge

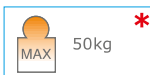
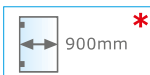
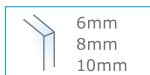

* È necessaria una battuta in chiusura in quanto la cerniera ha una precarica.
• Necesita de un cierre con tope, puesto que la bisagra tiene una precarga. • The hinge has a loading and it is therefore necessary a closing stop. • Eine Schließfeststellung ist notwendig, weil das Scharnier eine mechanische Belastung hat.

• Cerniera idraulica vetro-muro in battuta, con automatismo di chiusura integrato. Stop a +90°. Chiusura ermetica.

• Bisagra hidráulica vidrio-pared para puerta con tope, integrada de automatismo de cierre. Stop a + 90°. Sello hermético.

• Hydraulic hinge glass-wall with stop and integrated closing automatism. Stop at +90°. Hermetic closing.

• Hydraulikscharnier Glas-Wand mit Anschlag und integriertem, automatischem Schließmechanismus. Feststellung bei +90°. Hermetische Schließung.

S	A	B	Profilo - Perfil Seal - Profile
6mm	7mm	37mm	8PT8-10
8mm	9mm	35mm	8PT8-10
10mm	8mm	36mm	8PT1-10

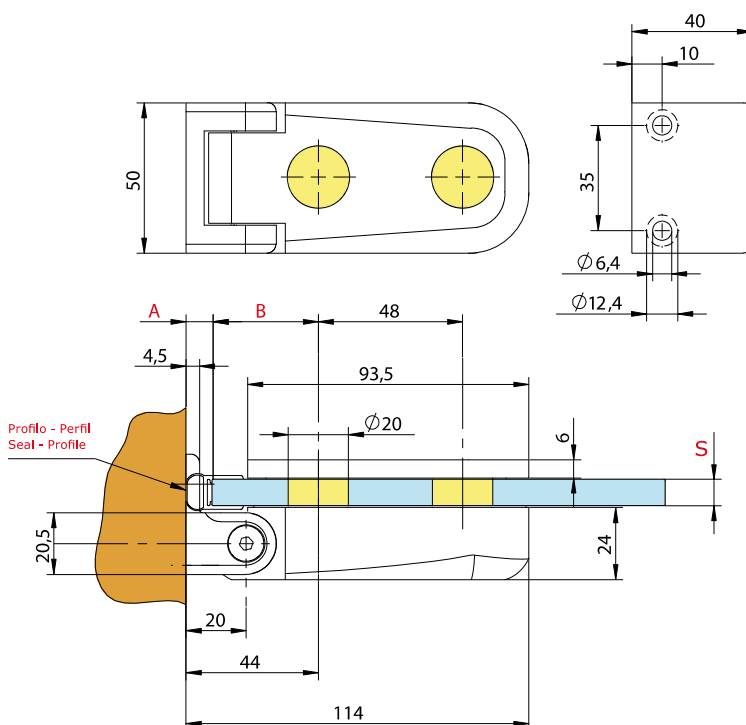
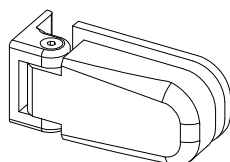

* • Per porte con peso superiore ai 50 kg e di larghezza oltre 800 mm si consiglia l'utilizzo di n° 3 cerniere • Para puertas con un peso superior a los 50 kg y con más de 800 mm de ancho se aconseja utilizar 3 bisagras • For doors with weight higher than 50 Kgs and largeness higher than 800 mm we suggest to use 3 hinges • Für Türe mit größerem Gewicht als 50 Kgs und größerer Breite als 800 mm schlagen wir die Verwendung von 3 Beschlägen vor

815E 50N Bilobina oildynamic hinge

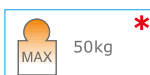
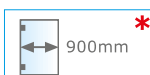

* È necessaria una battuta in chiusura in quanto la cerniera ha una precarica.
• Necesita de un cierre con tope, puesto que la bisagra tiene una precarga. • The hinge has a loading and it is therefore necessary a closing stop. • Eine Schließfeststellung ist notwendig, weil das Scharnier eine mechanische Belastung hat.

• Cerniera idraulica vetro-vetro in battuta, con automatismo di chiusura integrato. Stop a +90°. Chiusura ermetica.

• Bisagra hidráulica vidrio-vidrio para puerta con tope, integrada de automatismo de cierre. Stop a + 90°. Sello hermético.

• Hydraulic hinge glass-glass with stop and integrated closing automatism. Stop at +90°. Hermetic closing.

• Hydraulikscharnier Glas-Glas mit Anschlag und integriertem, automatischem Schließmechanismus. Feststellung bei +90°. Hermetische Schließung.

S	A	B	Profilo - Perfil Seal - Profile
6mm	3.5mm	38.5mm	8PT8-30
8mm	5.5mm	37.5mm	8PT8-30
10mm	3.5mm	38.5mm	8PT1-30

